

# 14

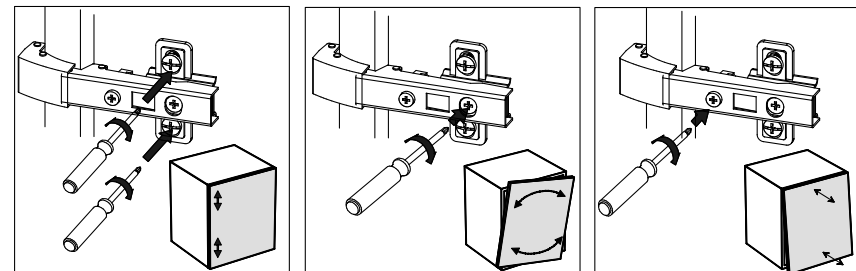

# MODELL: Y4

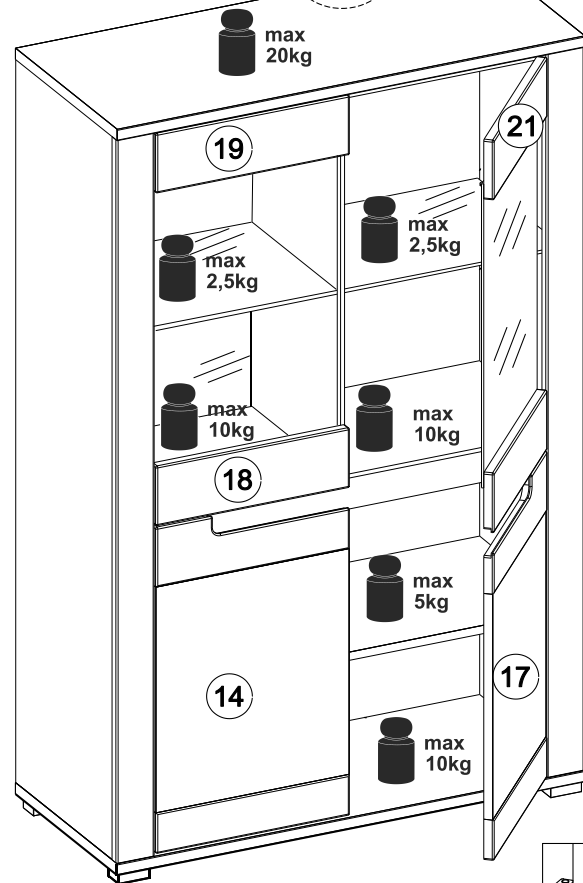
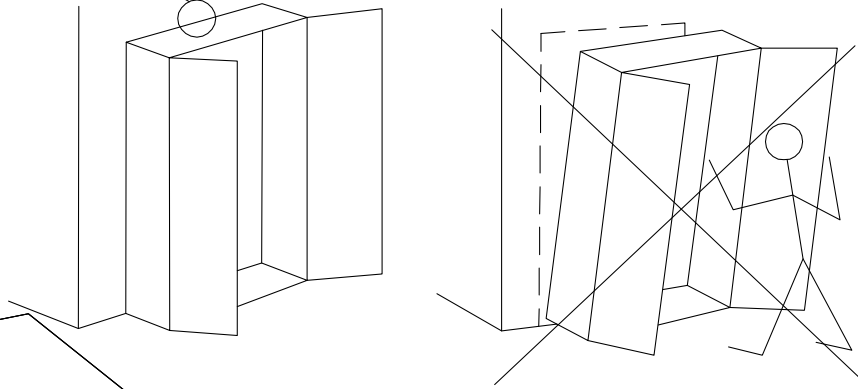
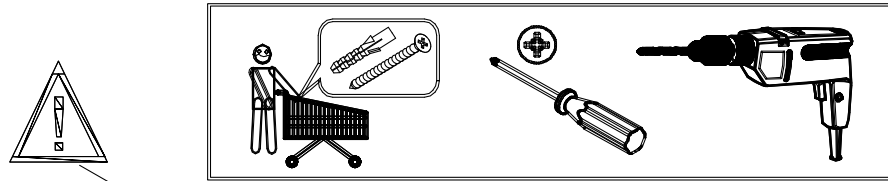
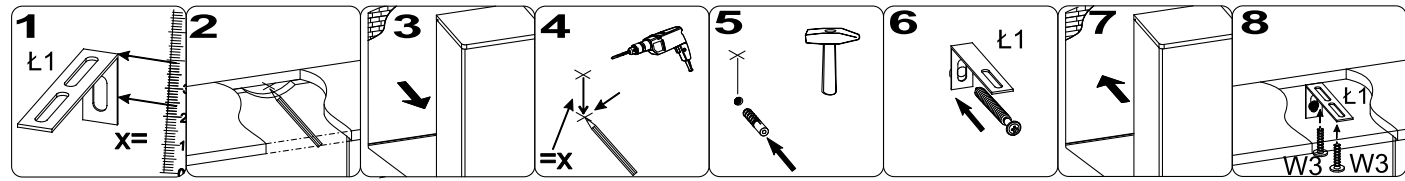
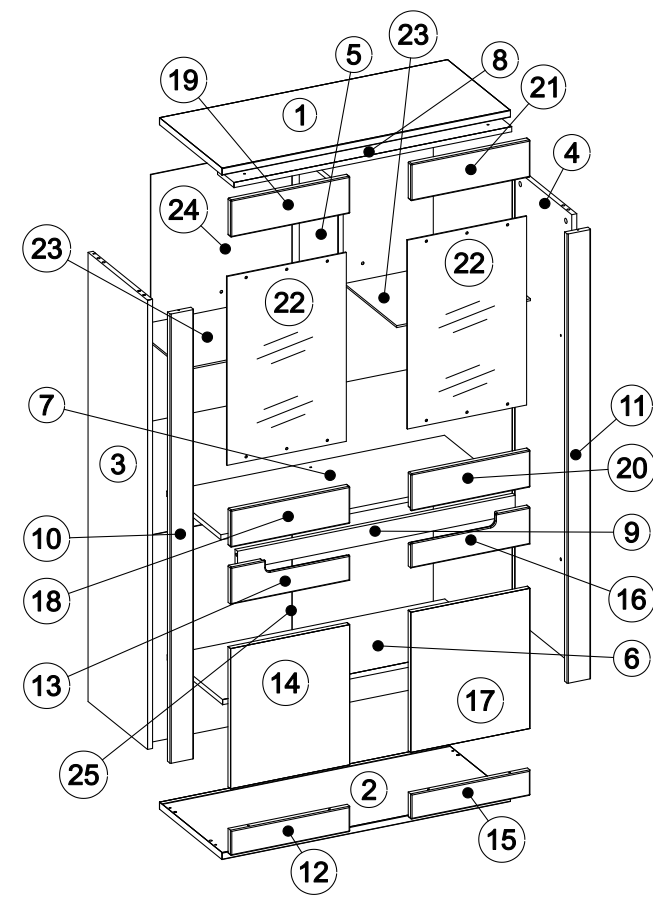
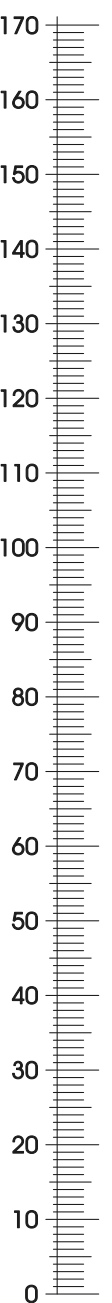
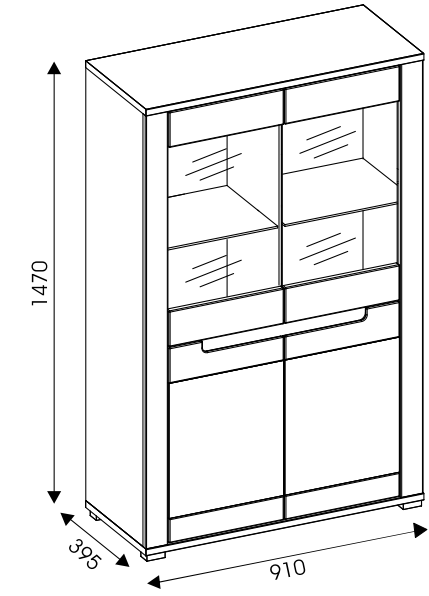
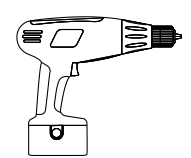
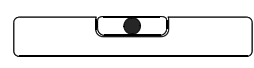
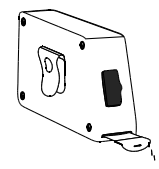
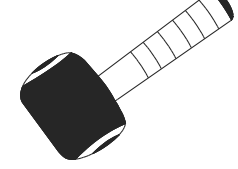
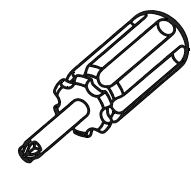
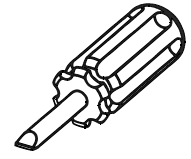
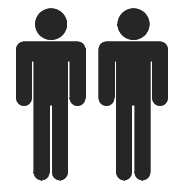
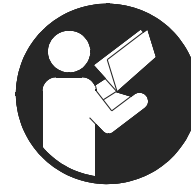
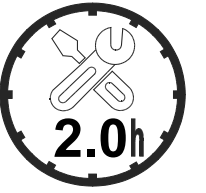

25	648x891	2/3
24	772x891	2/3
23	422x330	3/3
22	591x376	3/3
21	376x116	3/3
20	376x116	3/3
19	376x116	3/3
18	376x116	3/3
17	439x376	3/3
16	376x116	3/3
15	376x79	3/3
14	439x376	3/3
13	376x116	3/3
12	376x79	3/3
11	1406x74	2/3
10	1406x74	2/3
9	876x60	1/3
8	876x104	1/3
7	876x341	1/3
6	876x350	1/3
5	757x245	1/3
4	1406x375	2/3
3	1406x375	2/3
2	909x396	1/3
1	909x396	1/3

1x OPTION 2xNSP-3D/WW	1x L1	1x L1	3x Z10 #14/863	12x ZN3 4x16	WP3
4x BS1	9x 2x20 G1	12x TU1	16x ST1 3.5x16	32x WP1 3x20	16x W9 3x20
28x ZN1 #20/863	20x 8x30 K1	8x PR2 H=2	8x Z90	28x M1 #15/15	28x DU232T T1
				8x KM1	3x WM1 4x30
					20x W3 3.5x16
					8x E8 5x20

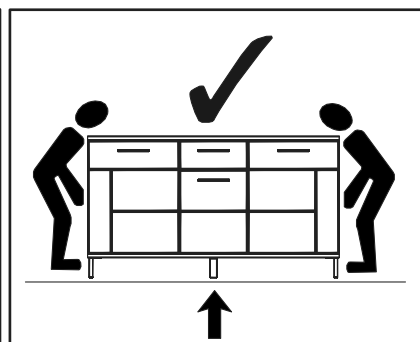
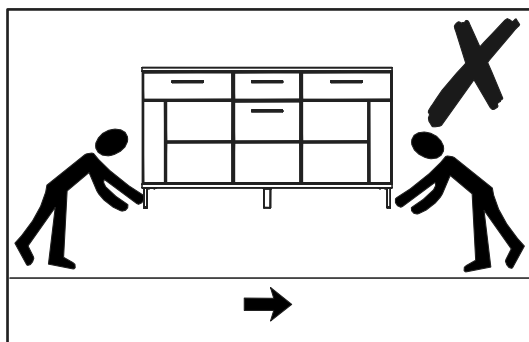
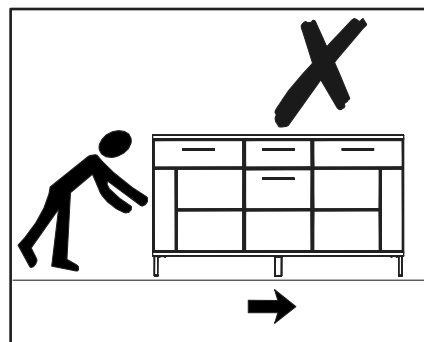
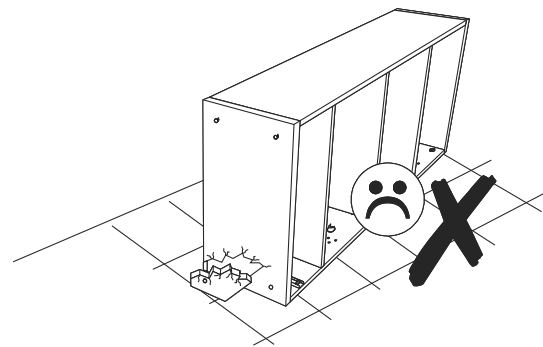
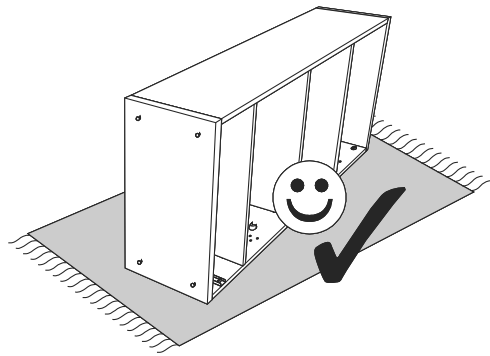
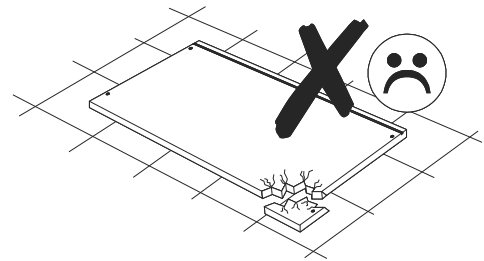
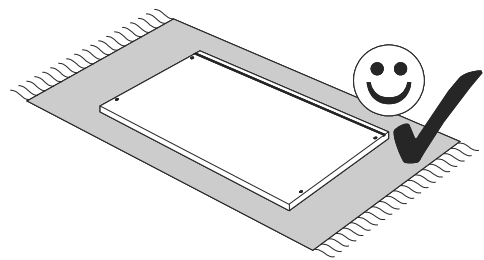
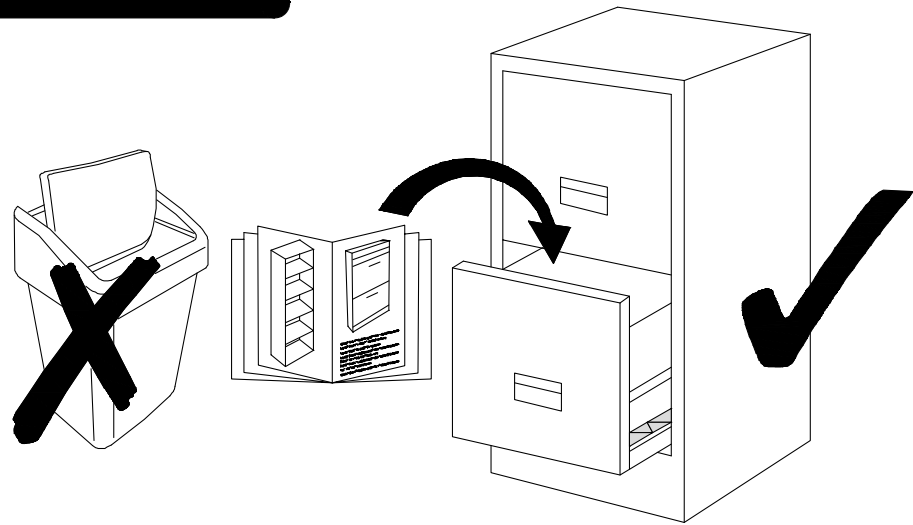

12

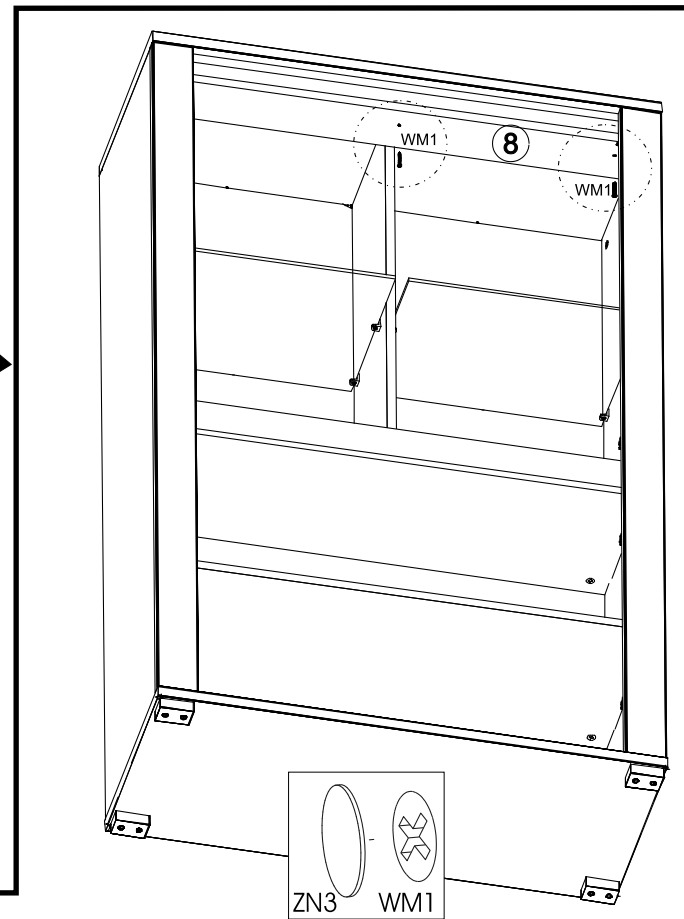
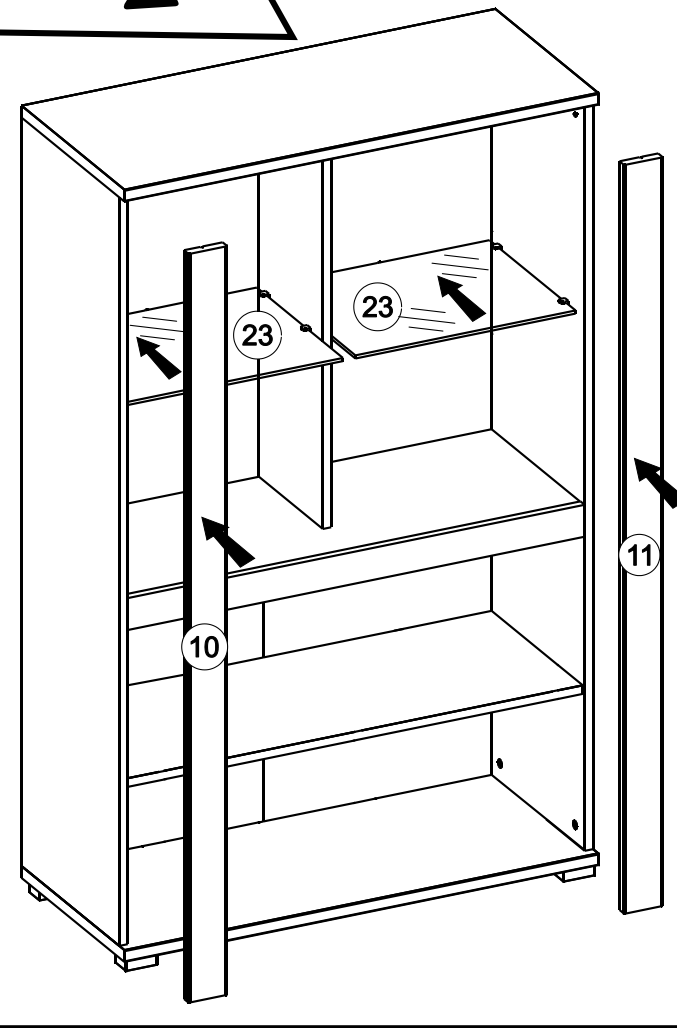
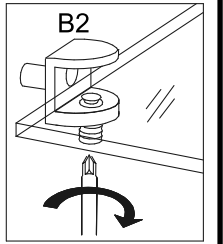
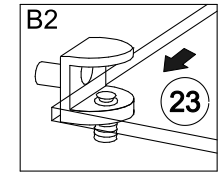
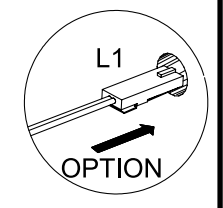
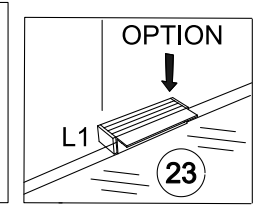
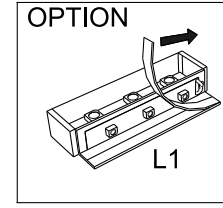
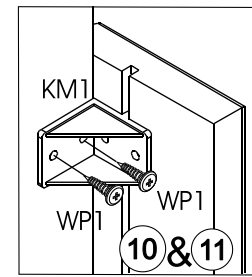
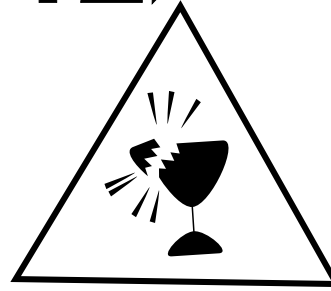

13

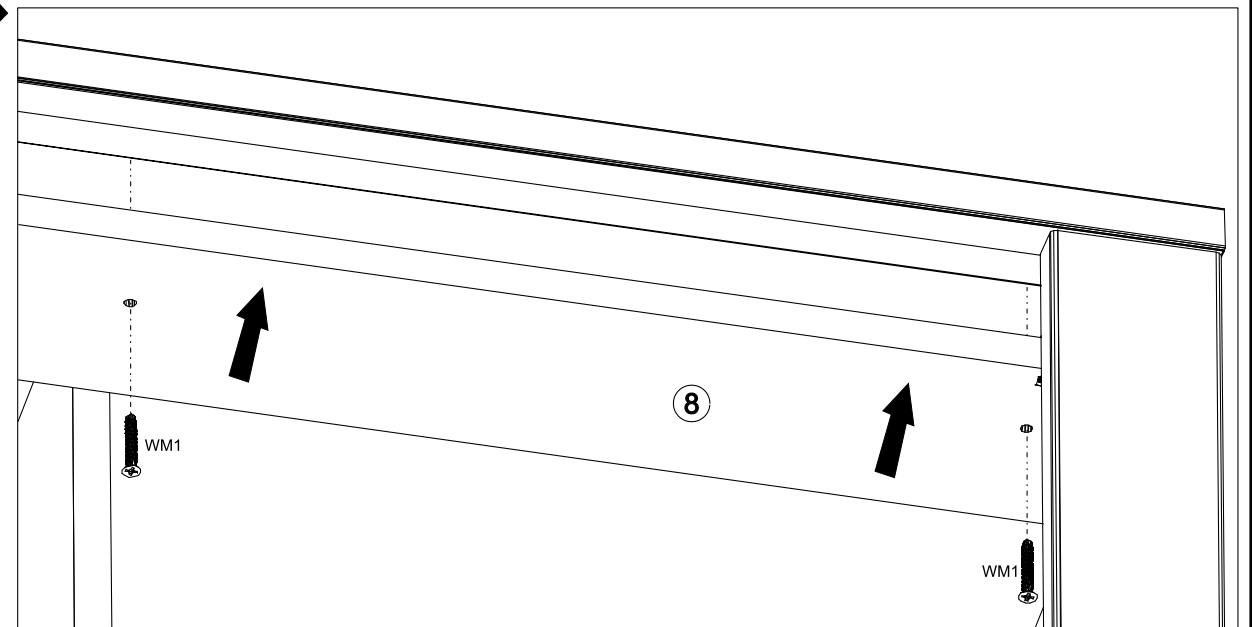

10

Y4

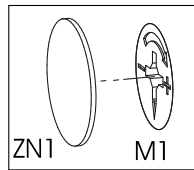
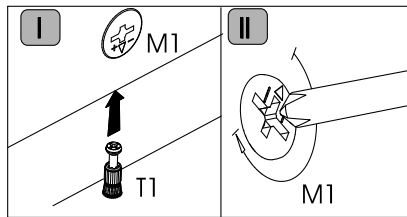
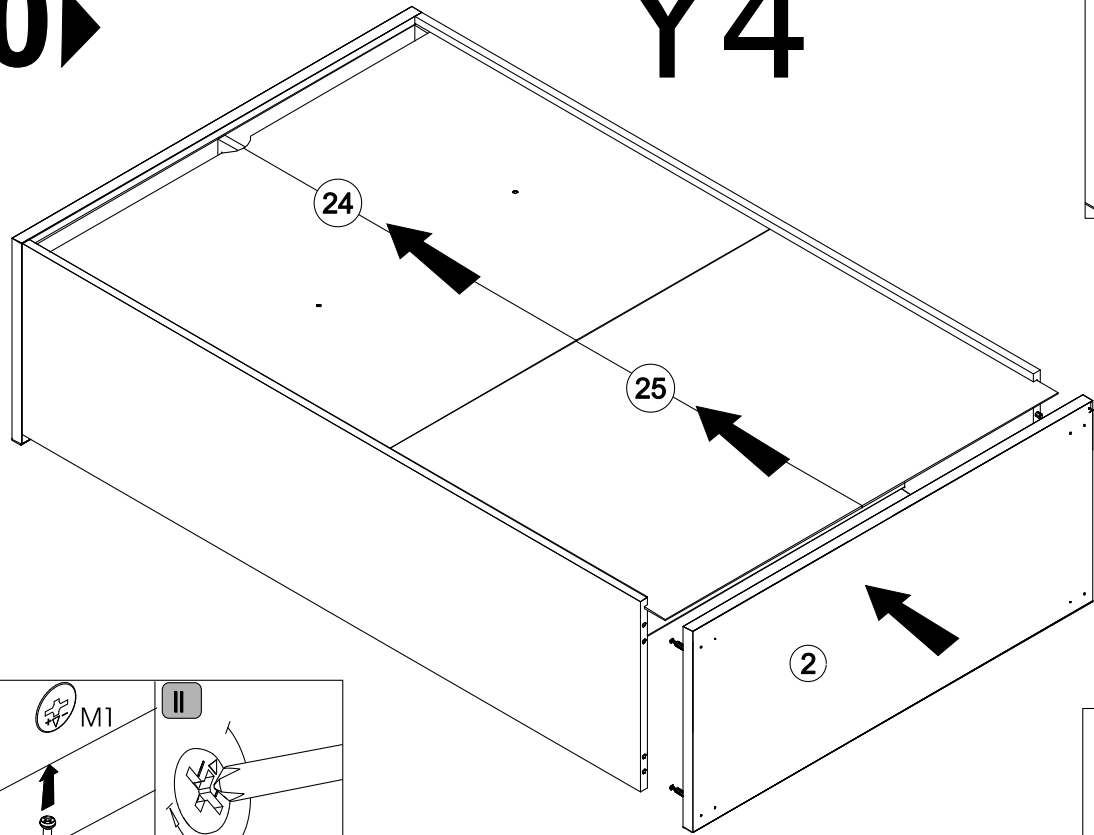
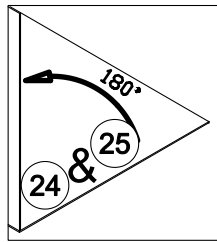

11

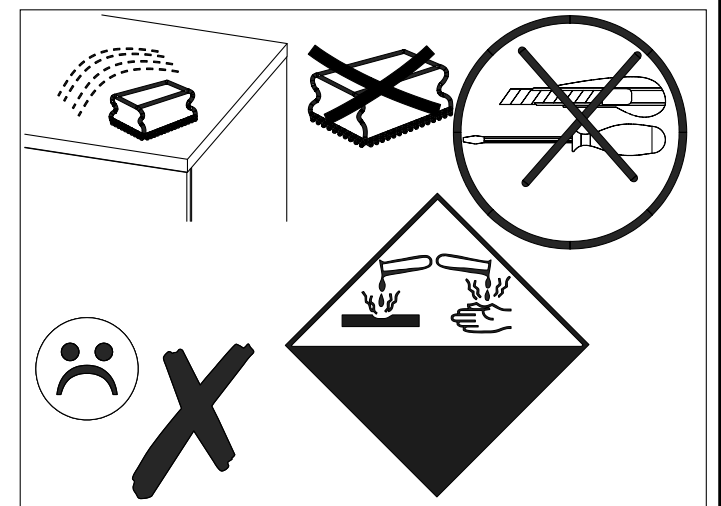
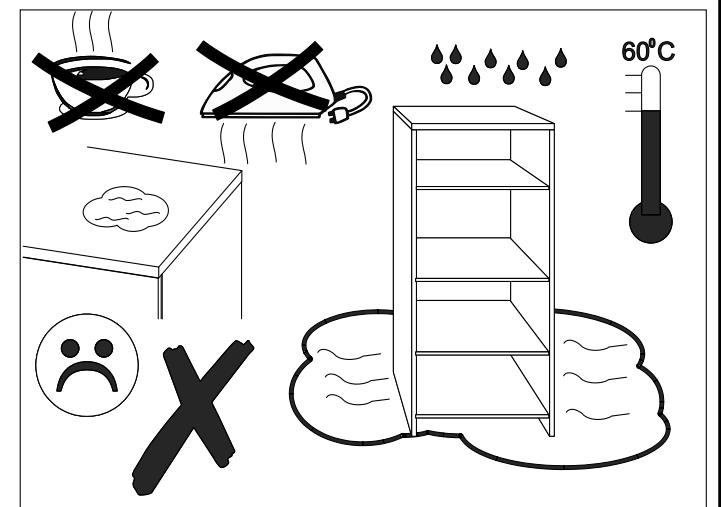
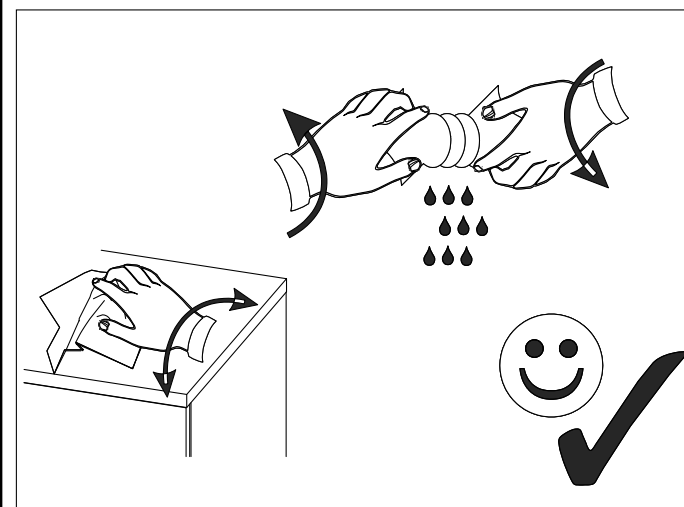
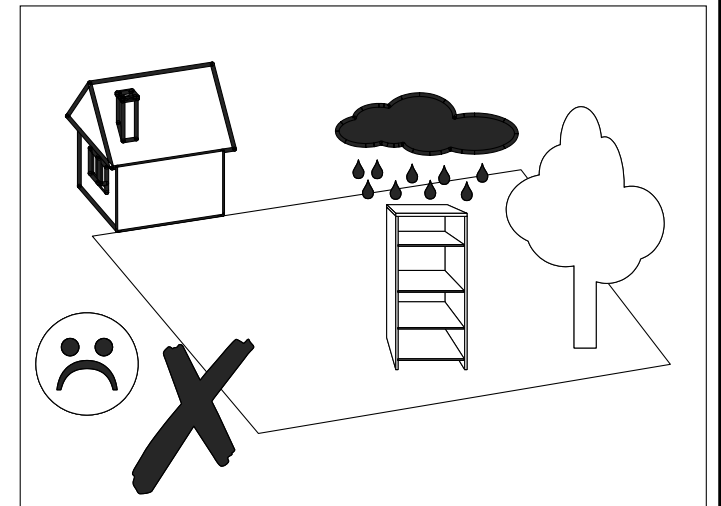
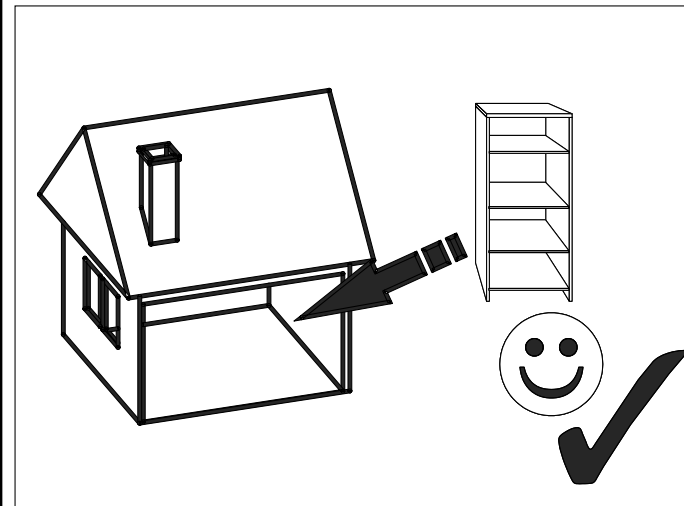
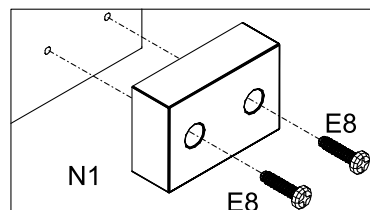
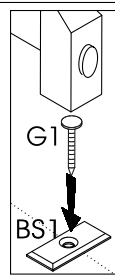
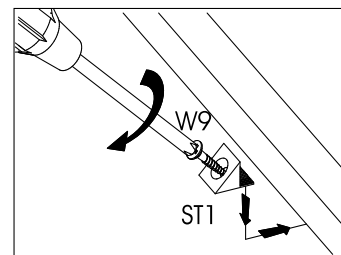
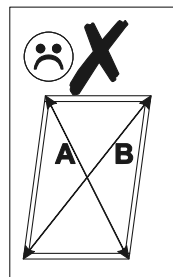
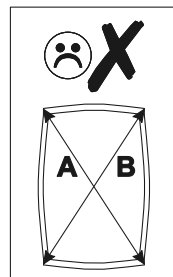
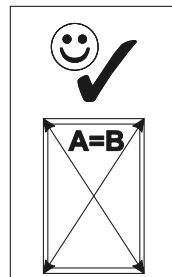
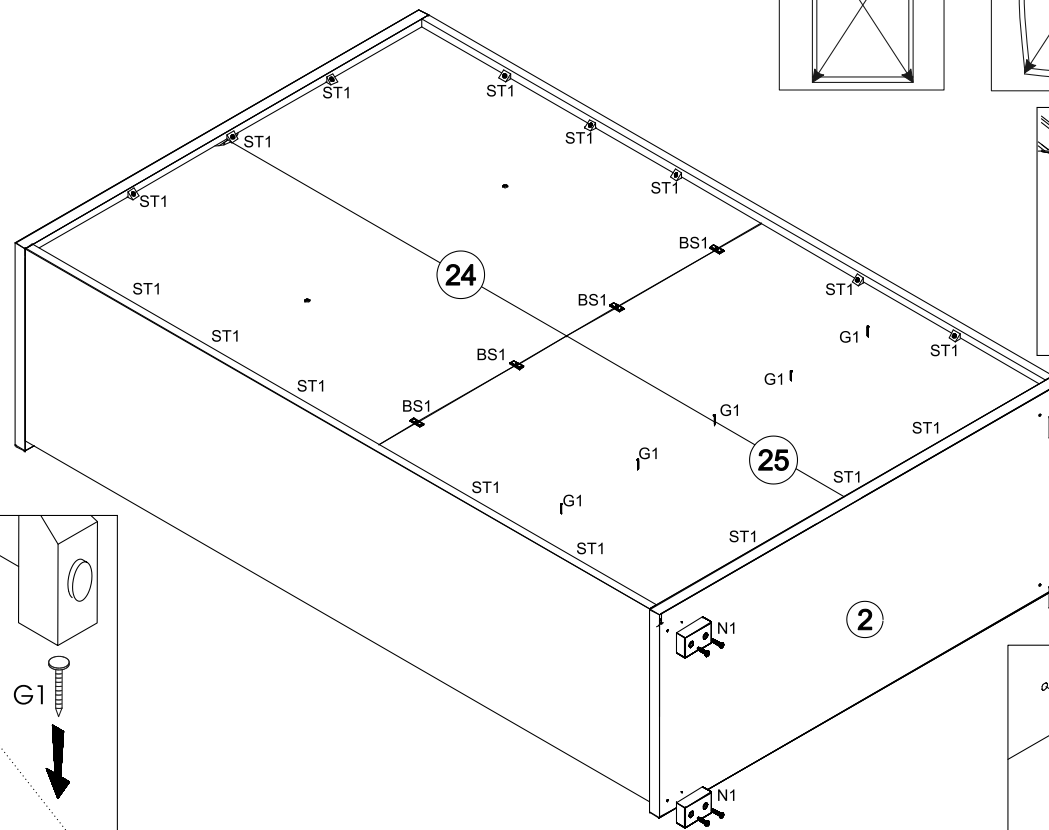

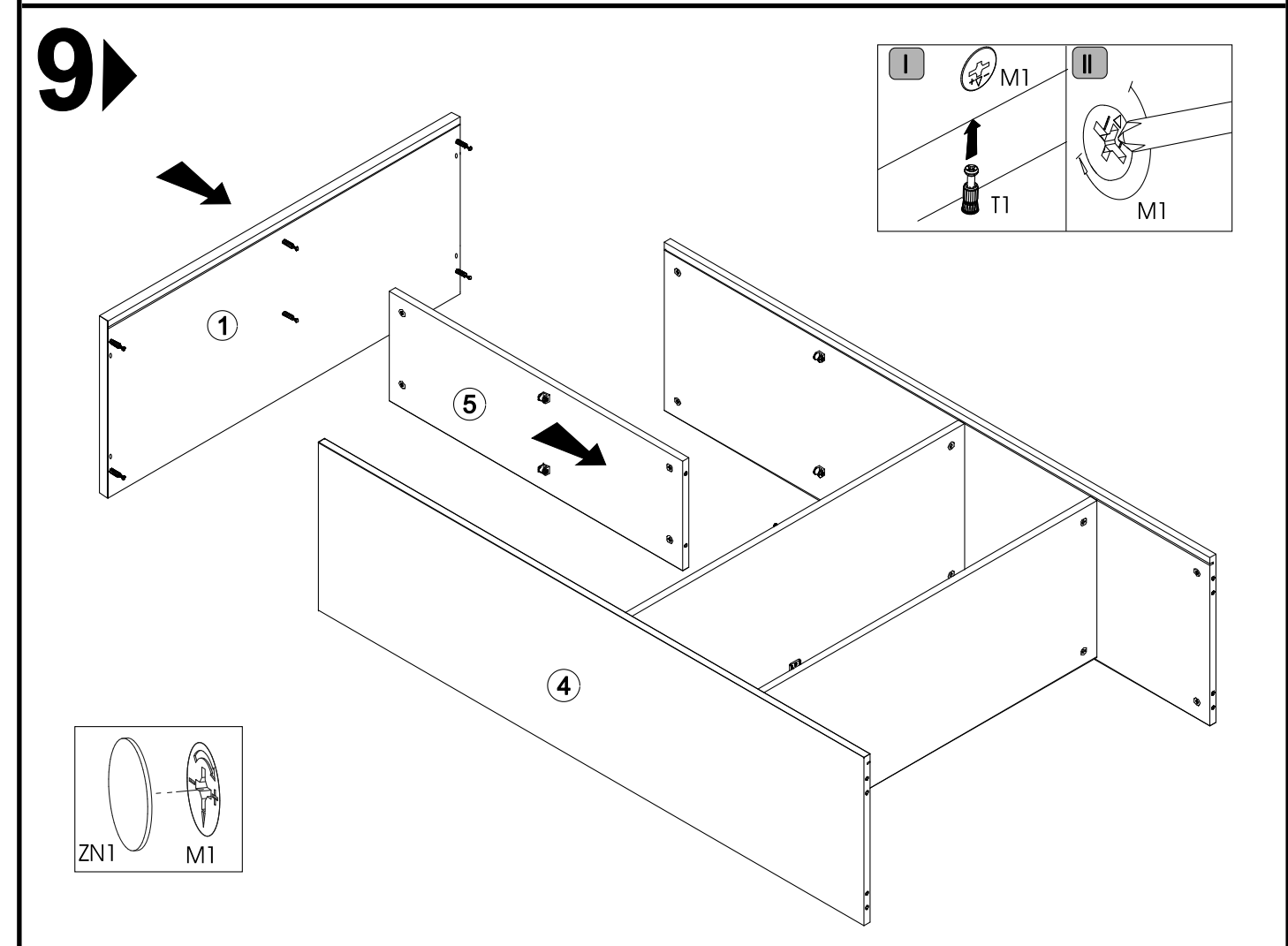
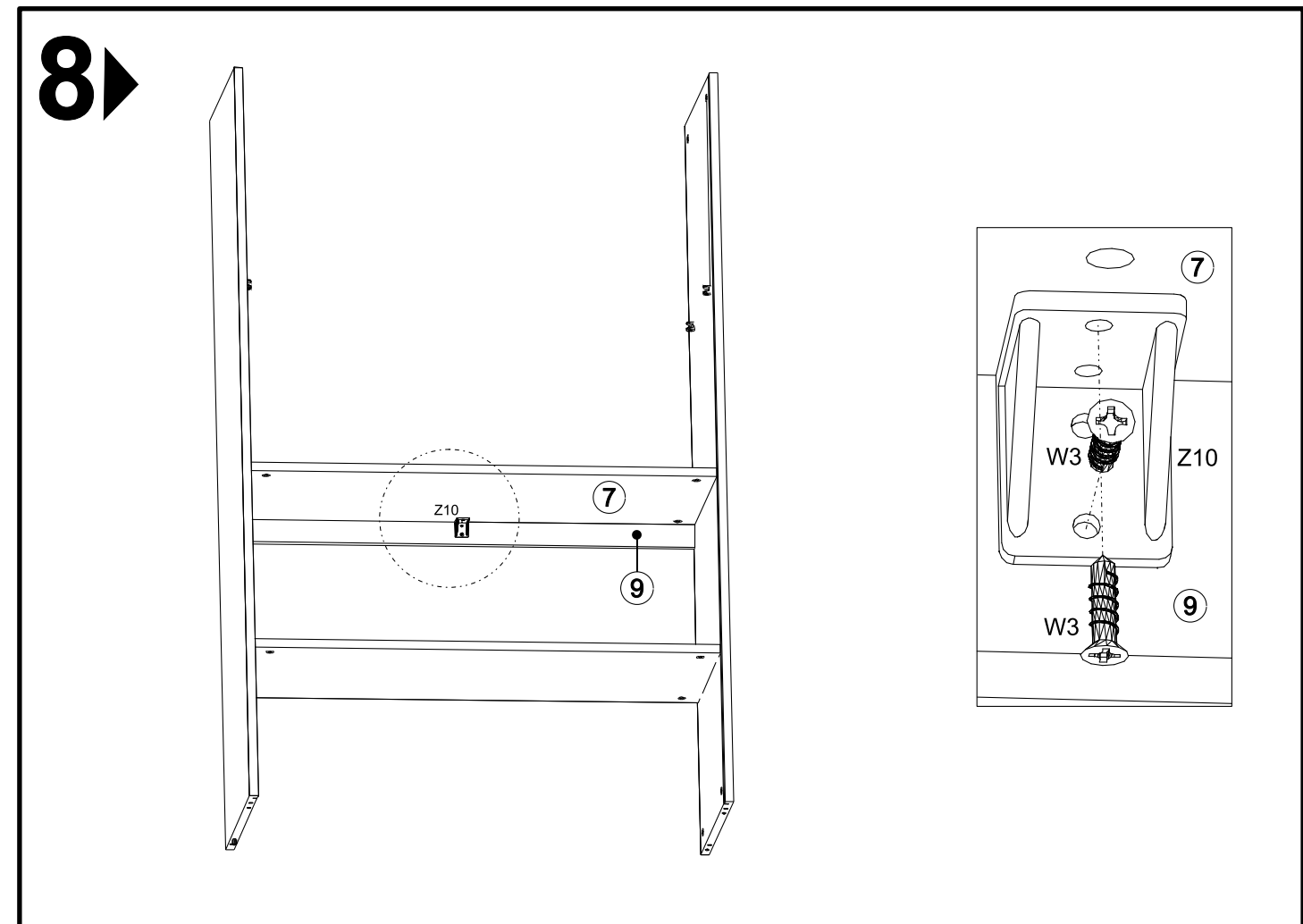
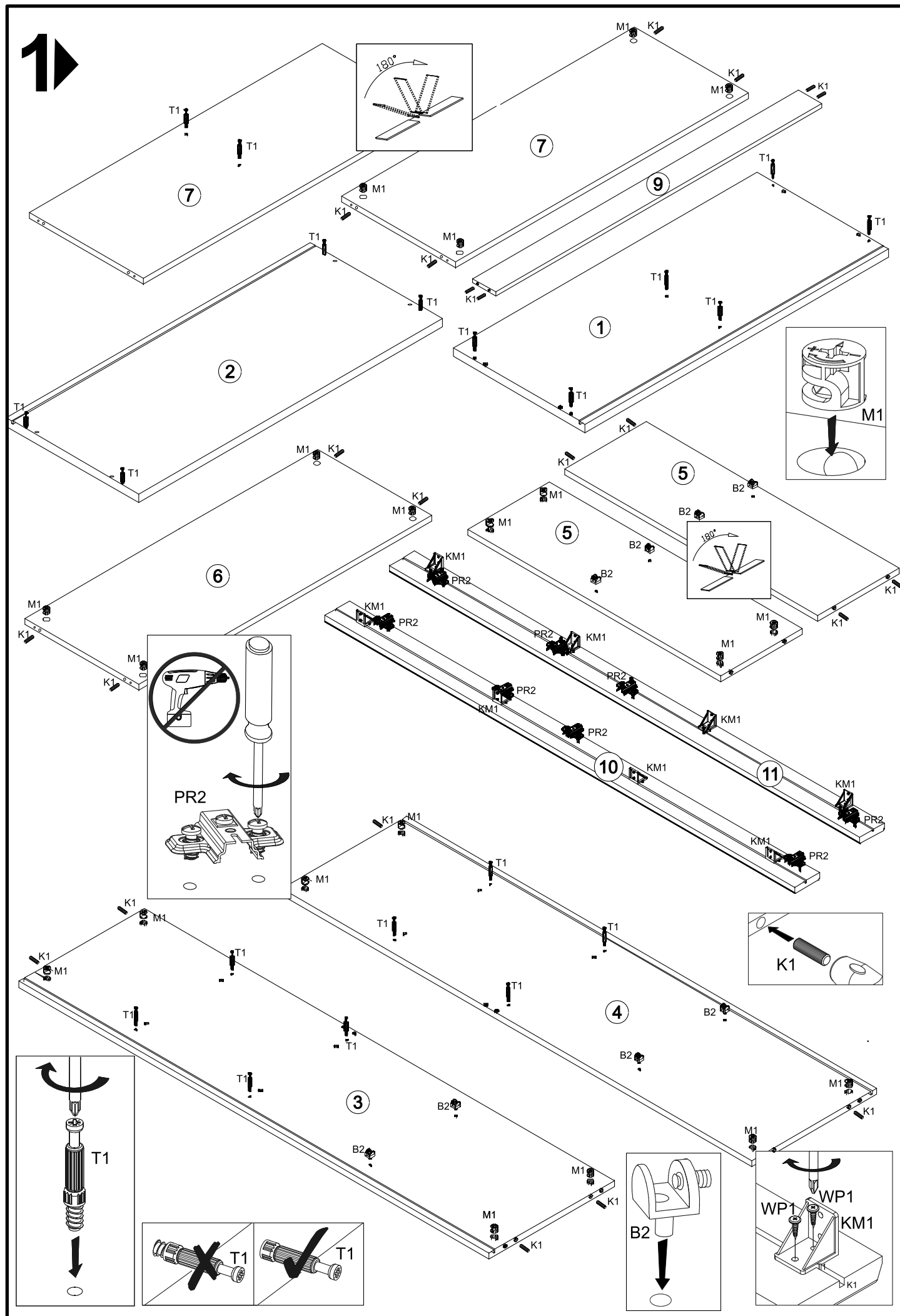

# 2

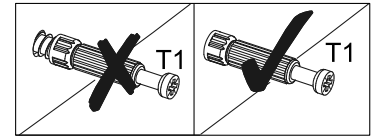
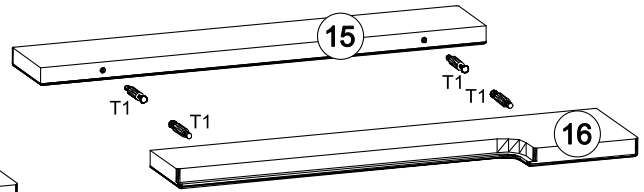
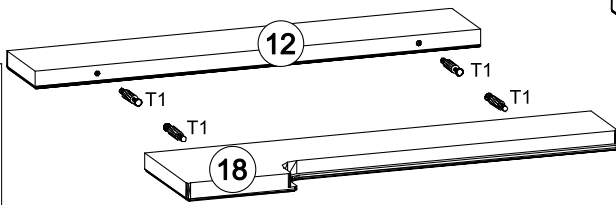
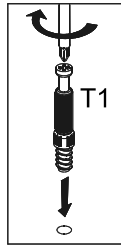

# 3

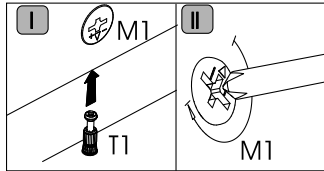
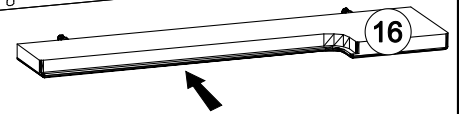
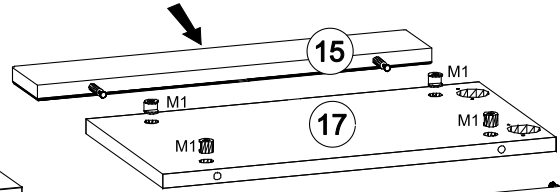
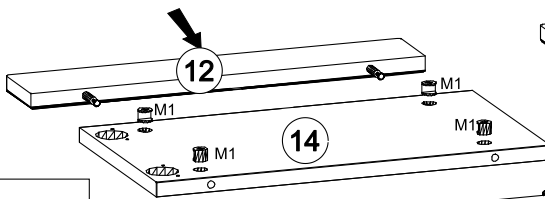
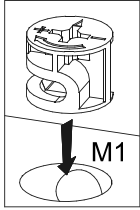

# 4

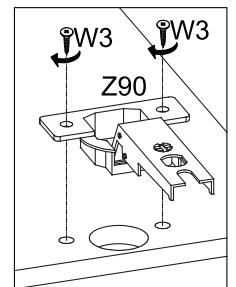
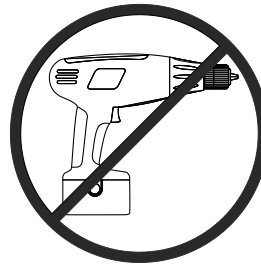
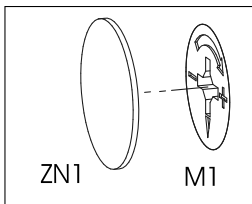
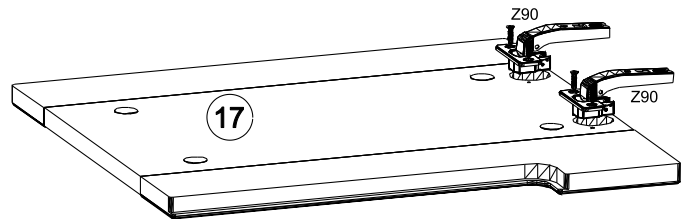
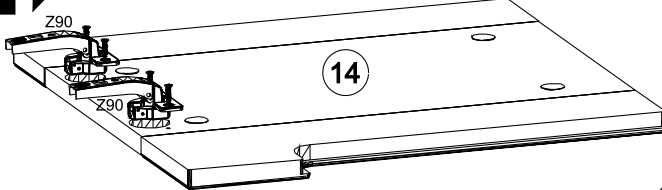

# 5

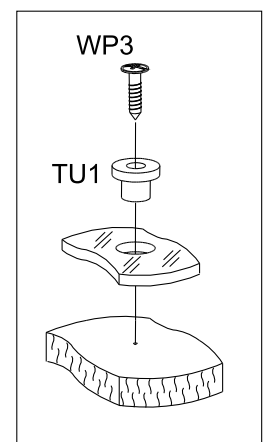
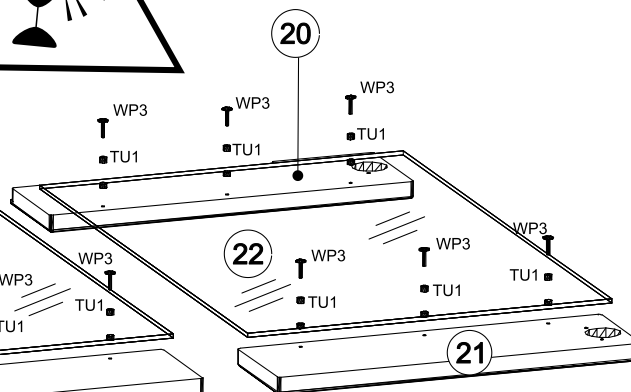
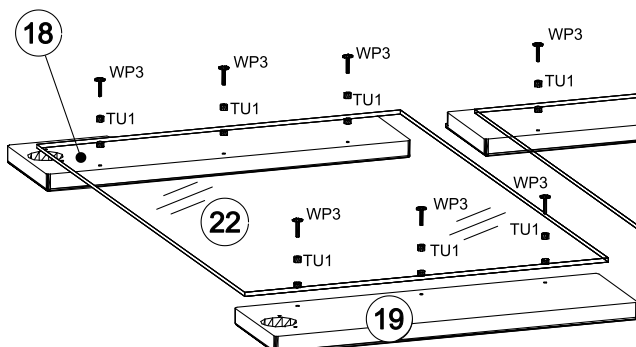

# 6▶

# Y4

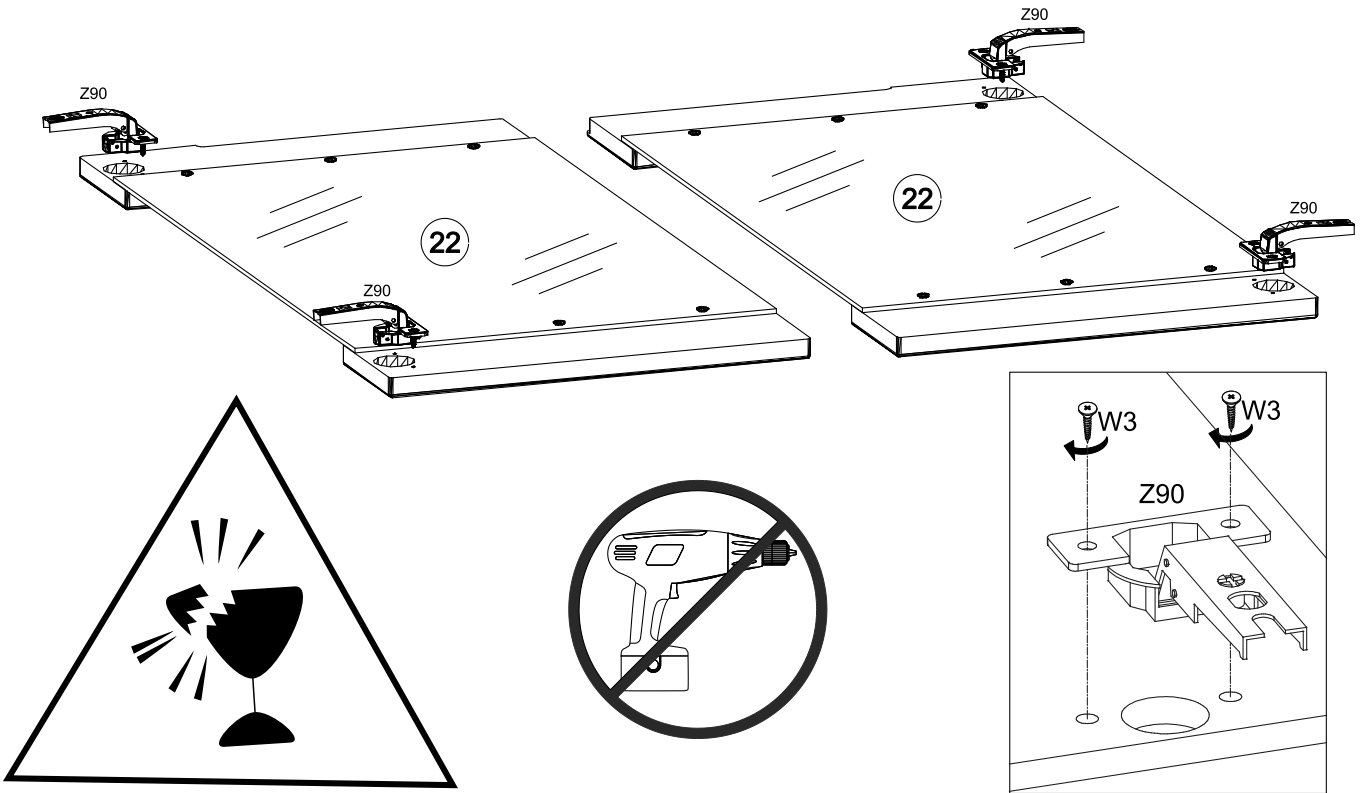

# 7▶

