

18▶

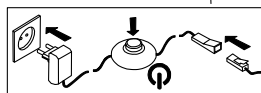

19▶

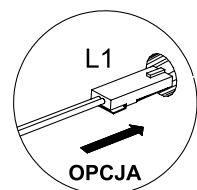
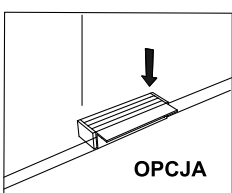
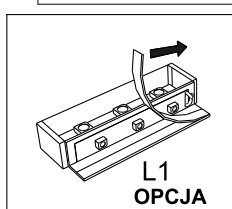
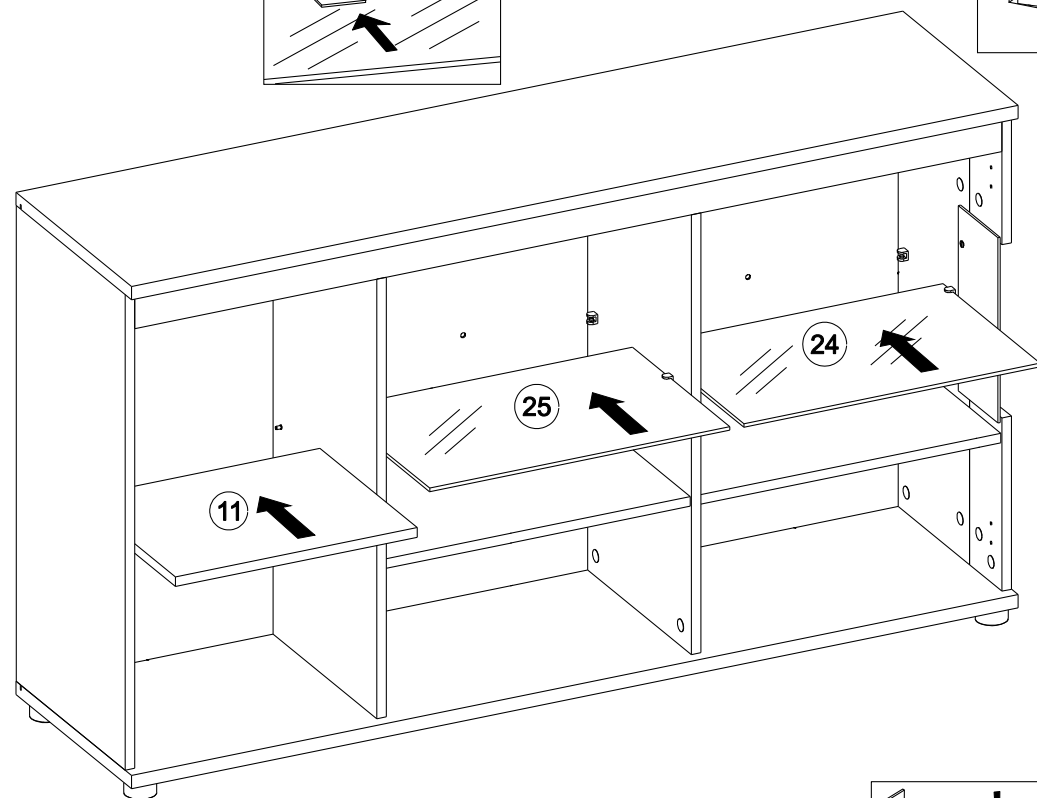
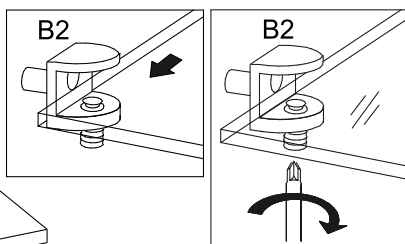
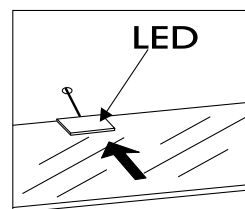
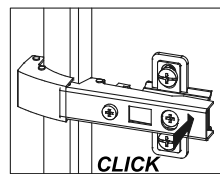
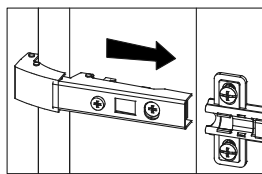
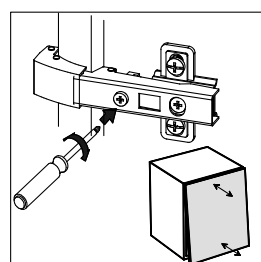
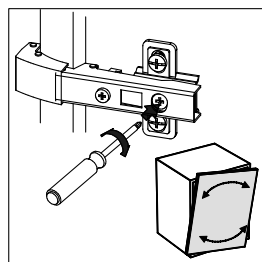
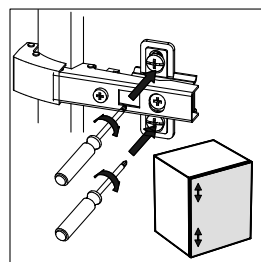
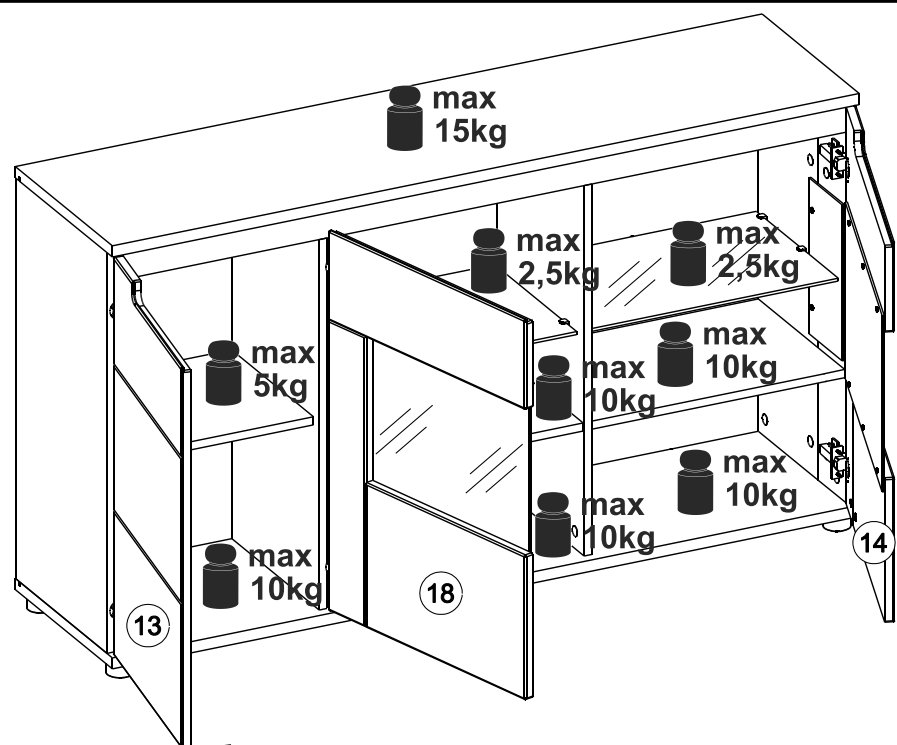

MODELL: PR4

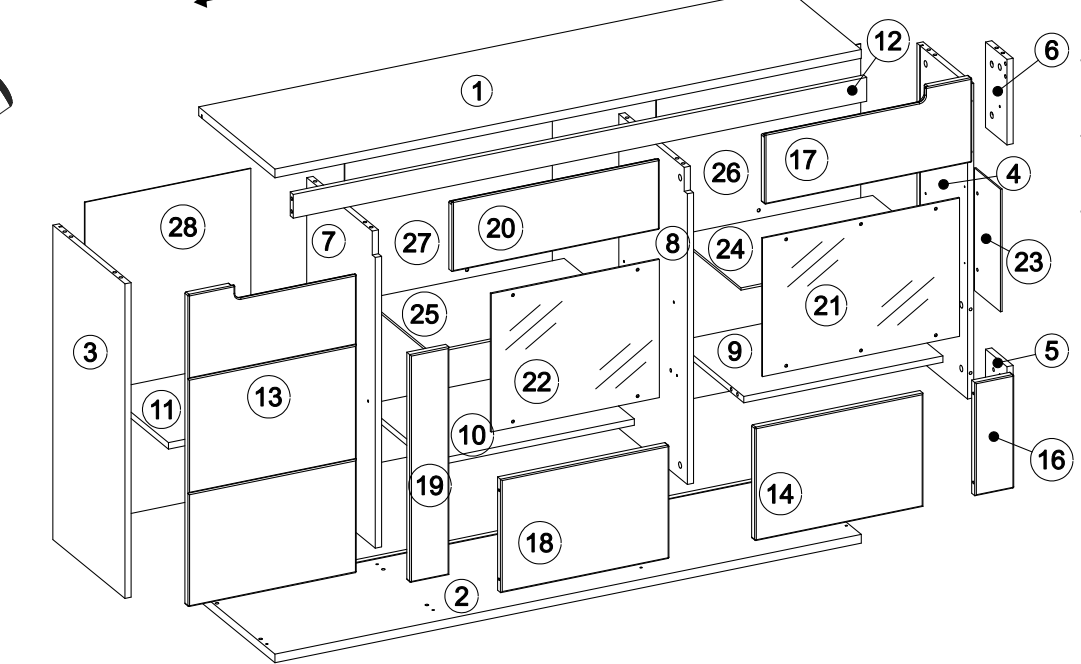
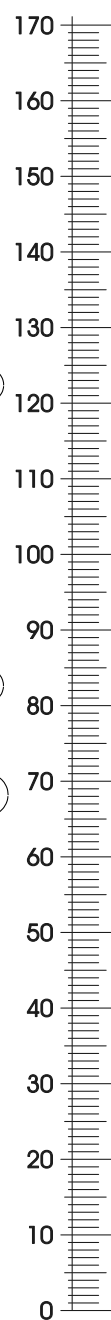
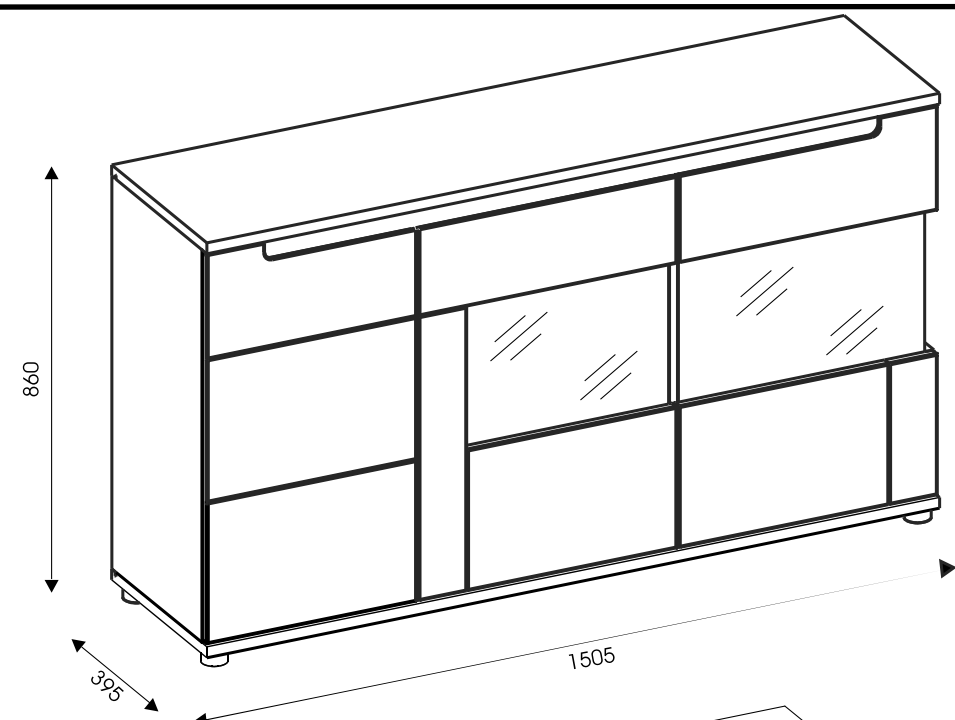
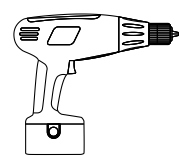
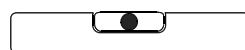
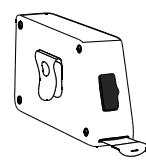
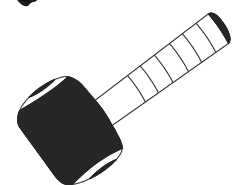
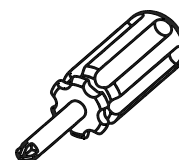
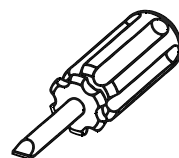
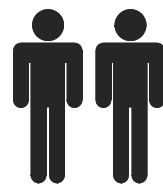

7	791x352	2/3	14	432x285	3/3	21	348x506	3/3	28	426x806	3/3
6	215x110	2/3	13	432x785	3/3	20	532x177	3/3	27	533x806	3/3
5	288x110	2/3	12	1472x60	1/3	19	573x100	3/3	26	525x806	2/3
4	791x260	2/3	11	410x330	1/3	18	432x285	3/3	25	510x330	2/3
3	791x370	2/3	10	518x348	1/3	17	532x212	3/3	24	503x330	3/3
2	1505x392	1/3	9	511x348	1/3	16	285x100	3/3	23	308x134	3/3
1	1505x392	1/3	8	791x352	2/3	14	432x285	3/3	22	348x432	3/3

4x	ZC0	12x	#20/320	1x	OPCJA	12x	WP4				
			ZN3	2x	NSP-3D/WW		L1				
32x	#20/863	16x	3.5x16	16x	W3	2x	ZC8	12x	TU1	16x	W9
					ST1				3x20		H=0
12x	BS1	28x	8x30	10x	56	8x	T3	44x	#15/15	24x	M1
			K1								DU232T
										2x	H1
										18x	G1
										4x	B1
										2x20	

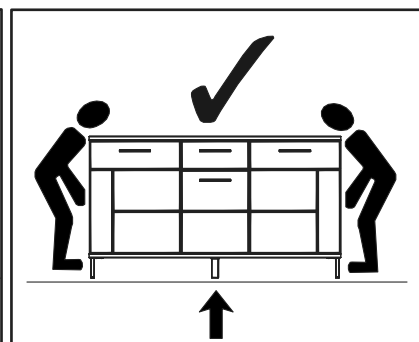
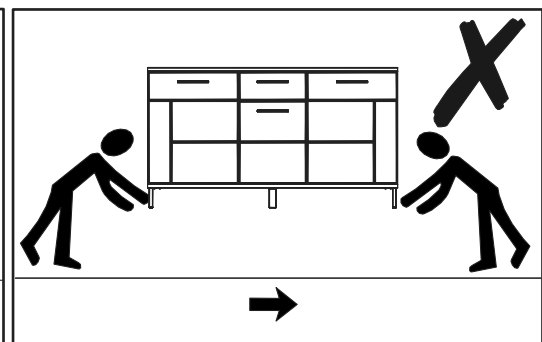
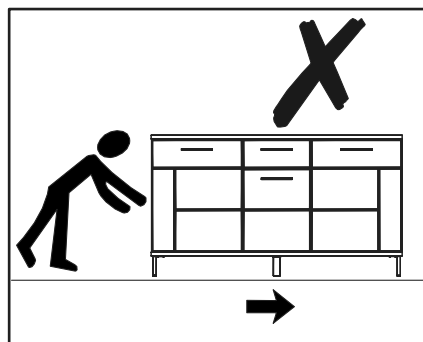
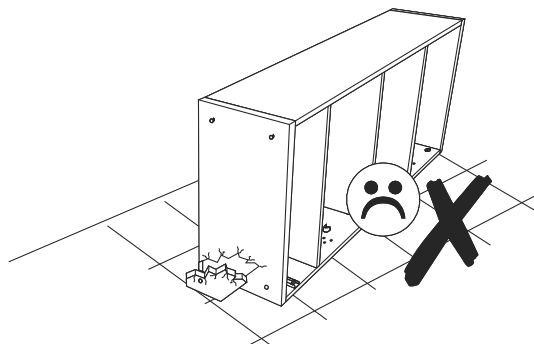
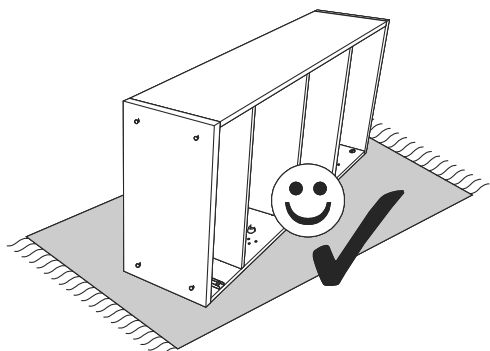
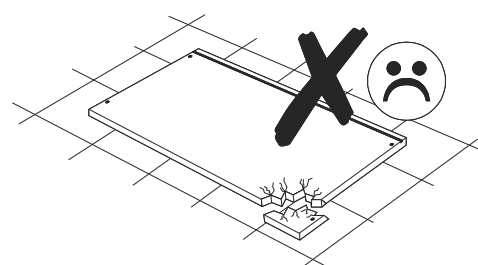
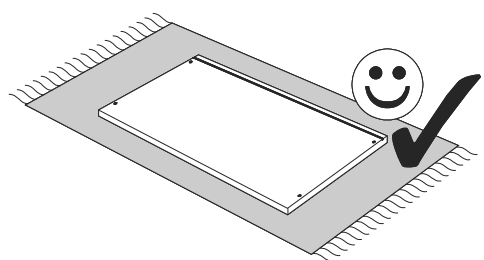
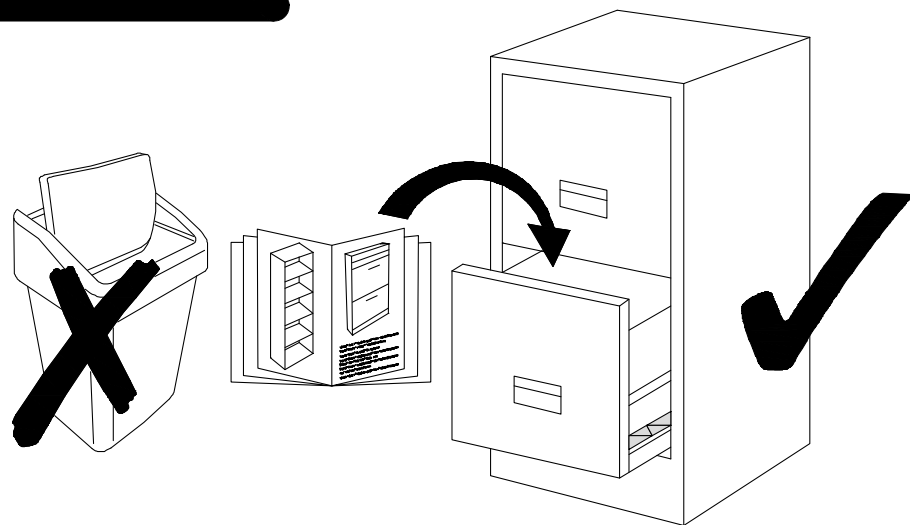

# 15

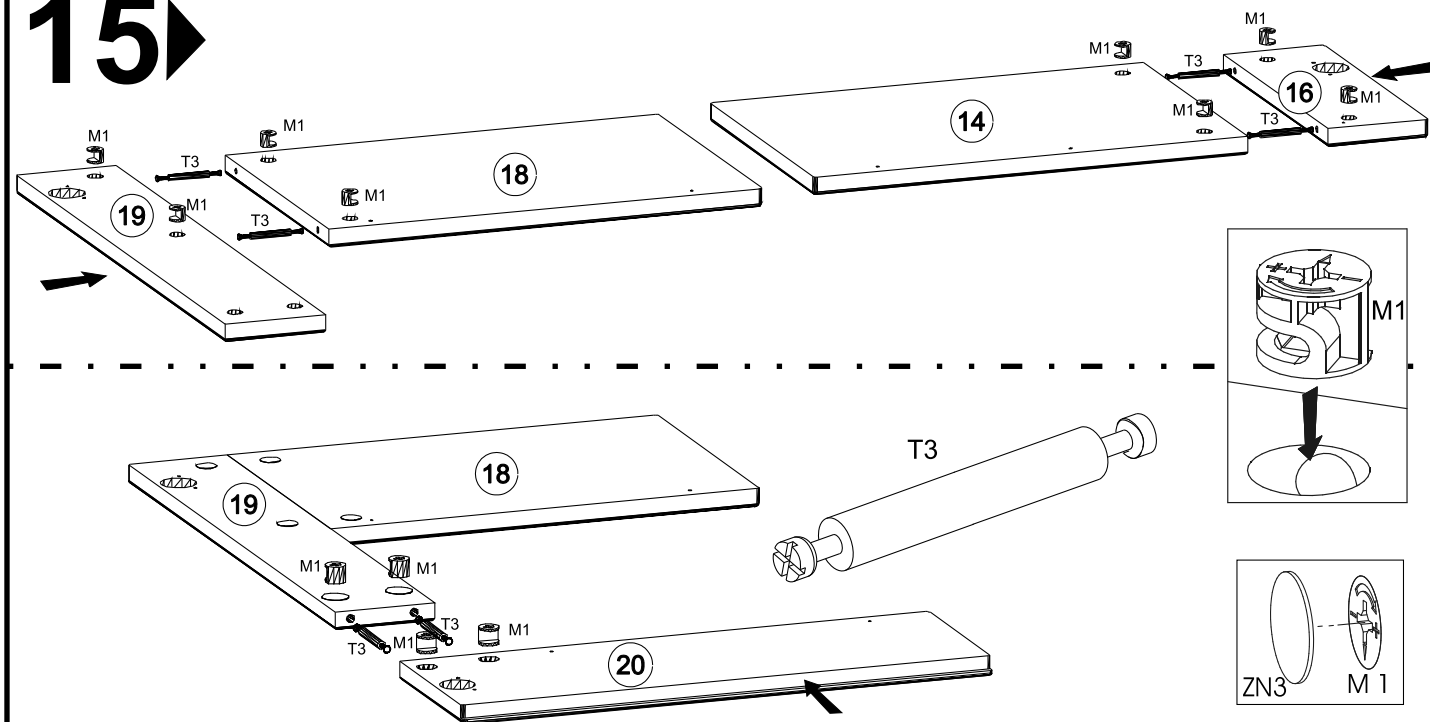

# 16

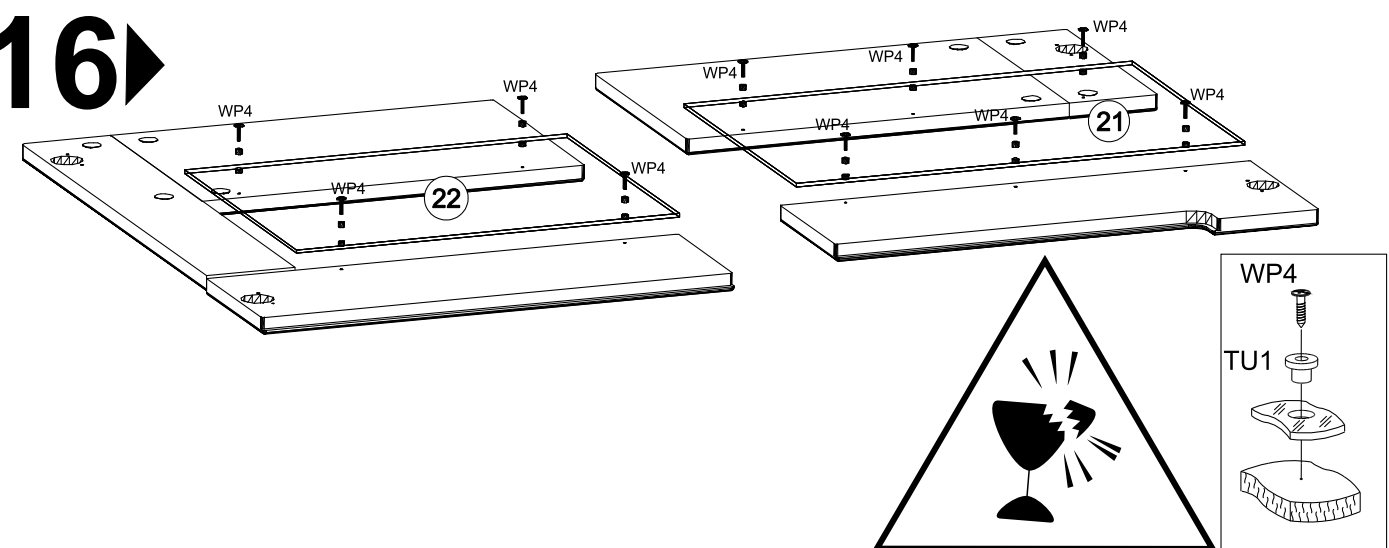

# 17

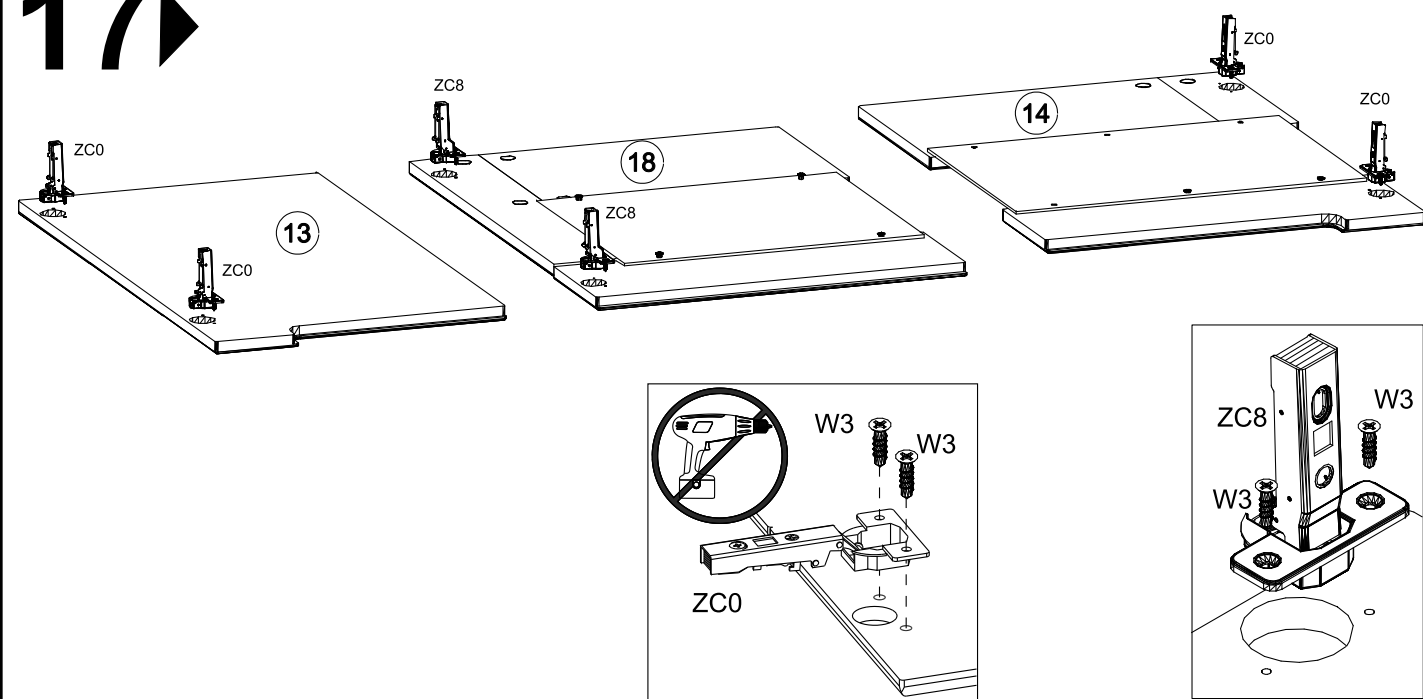

13

PR4

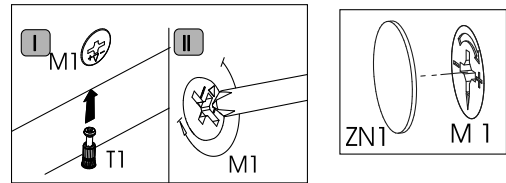
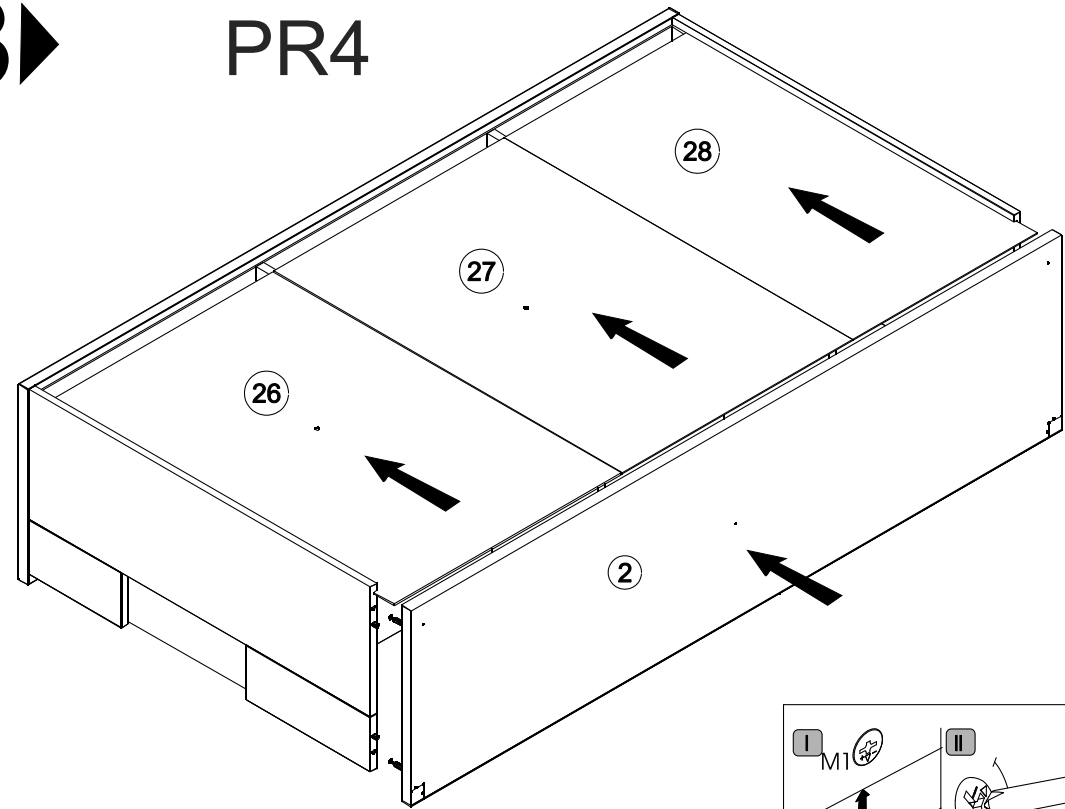

14

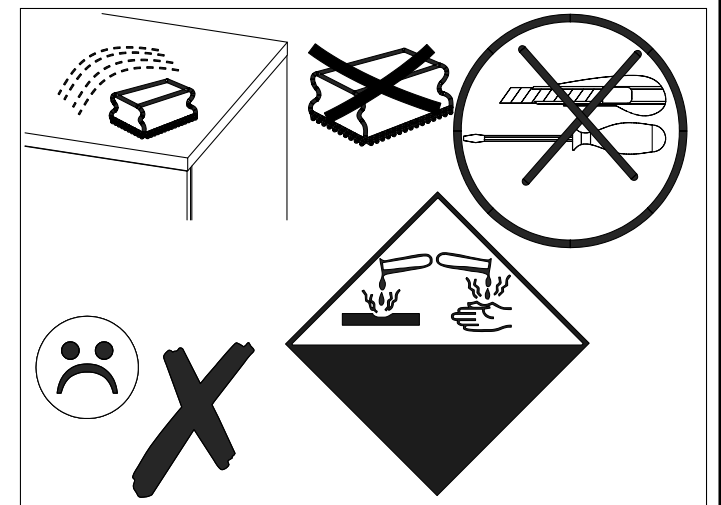
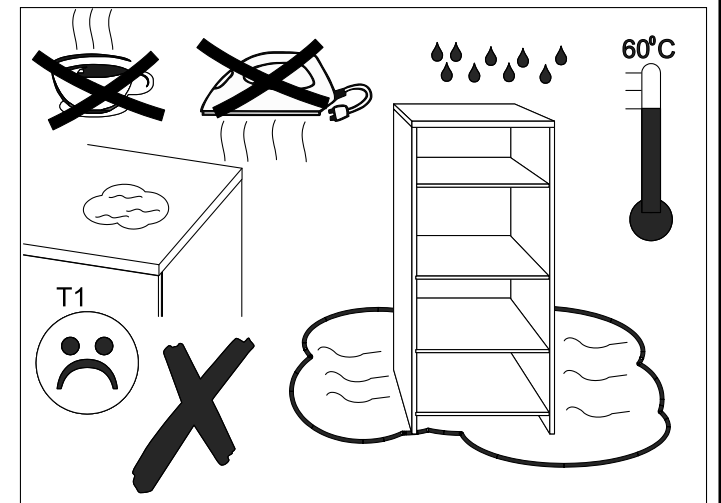
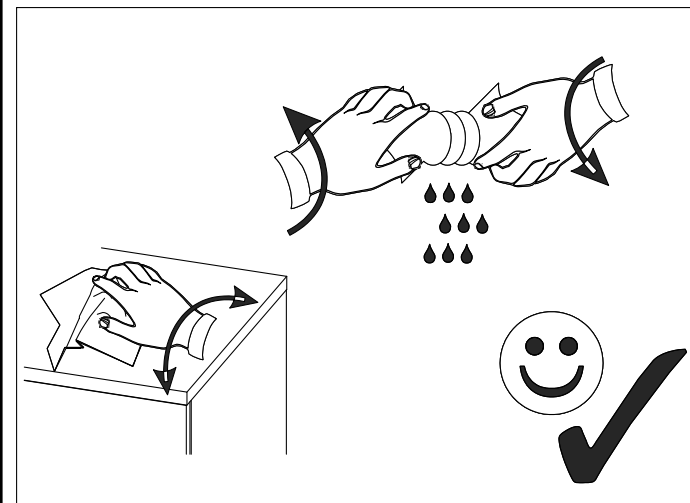
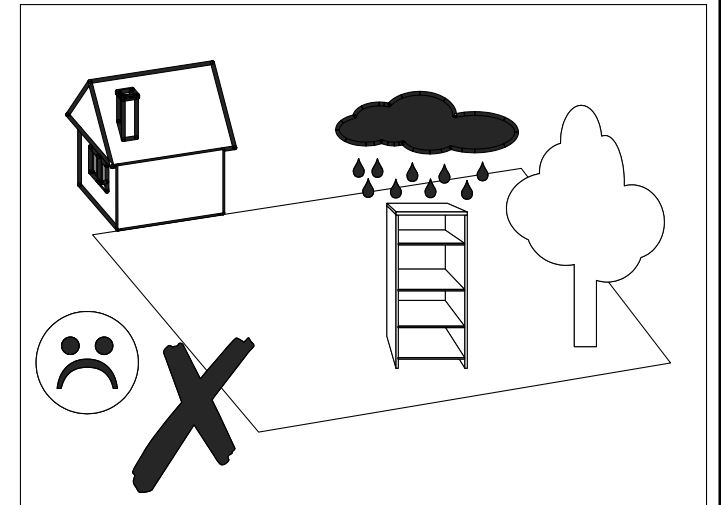
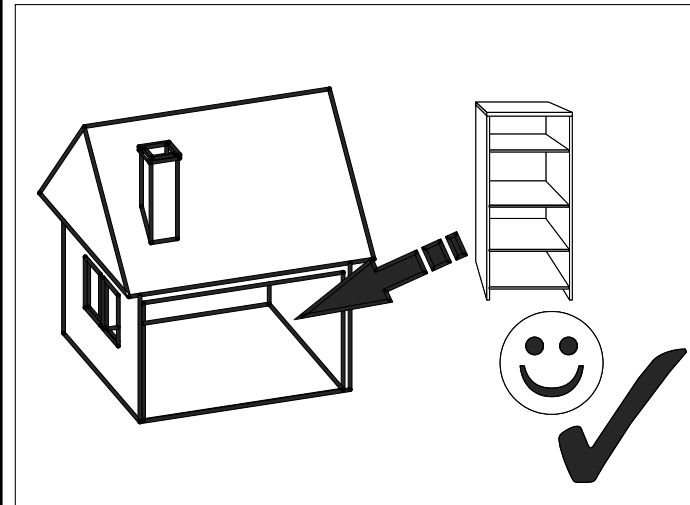
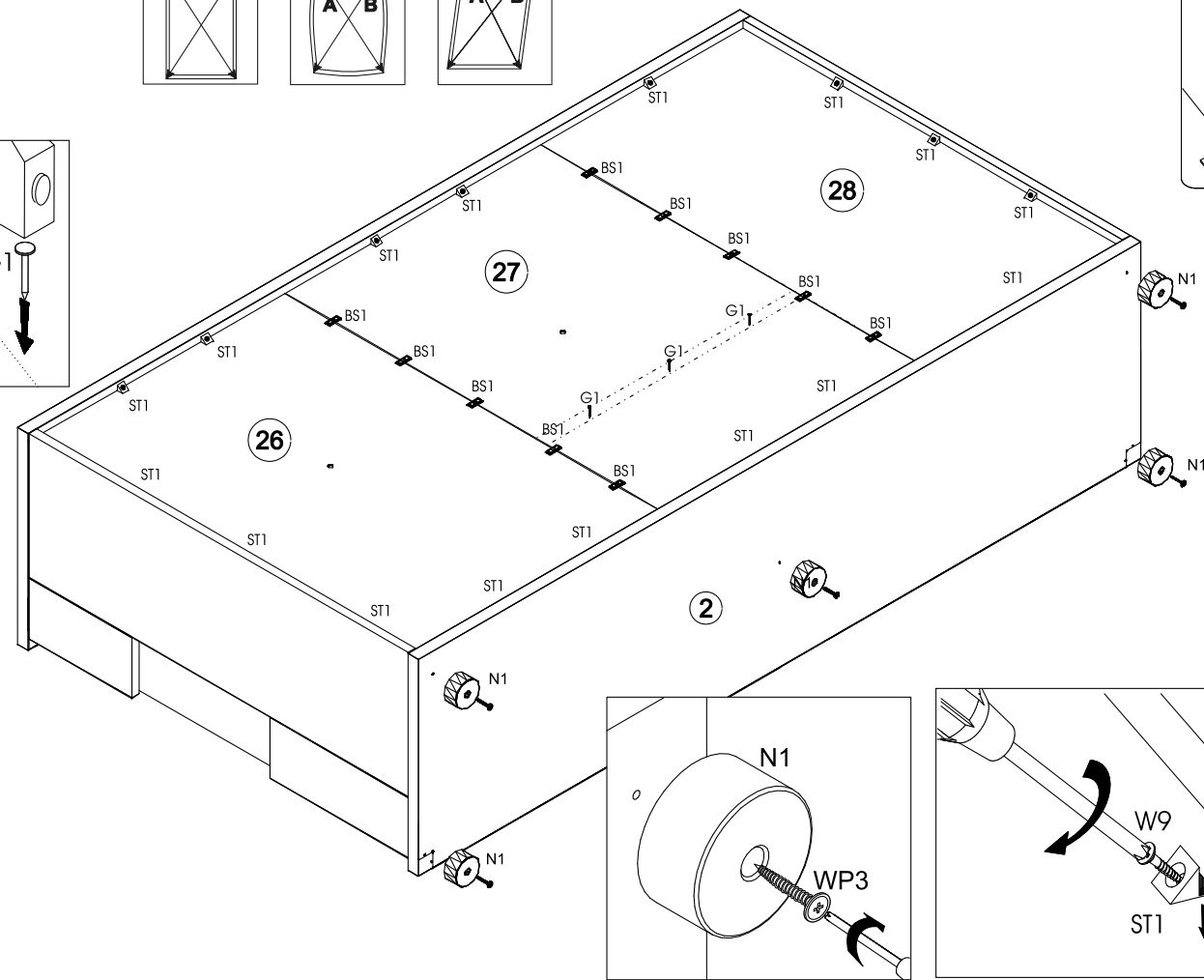
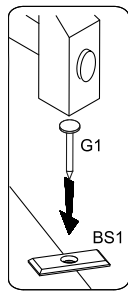
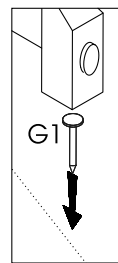
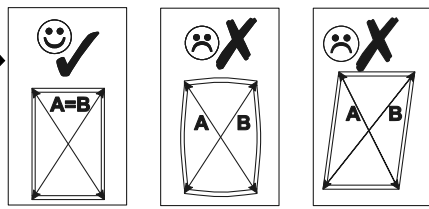

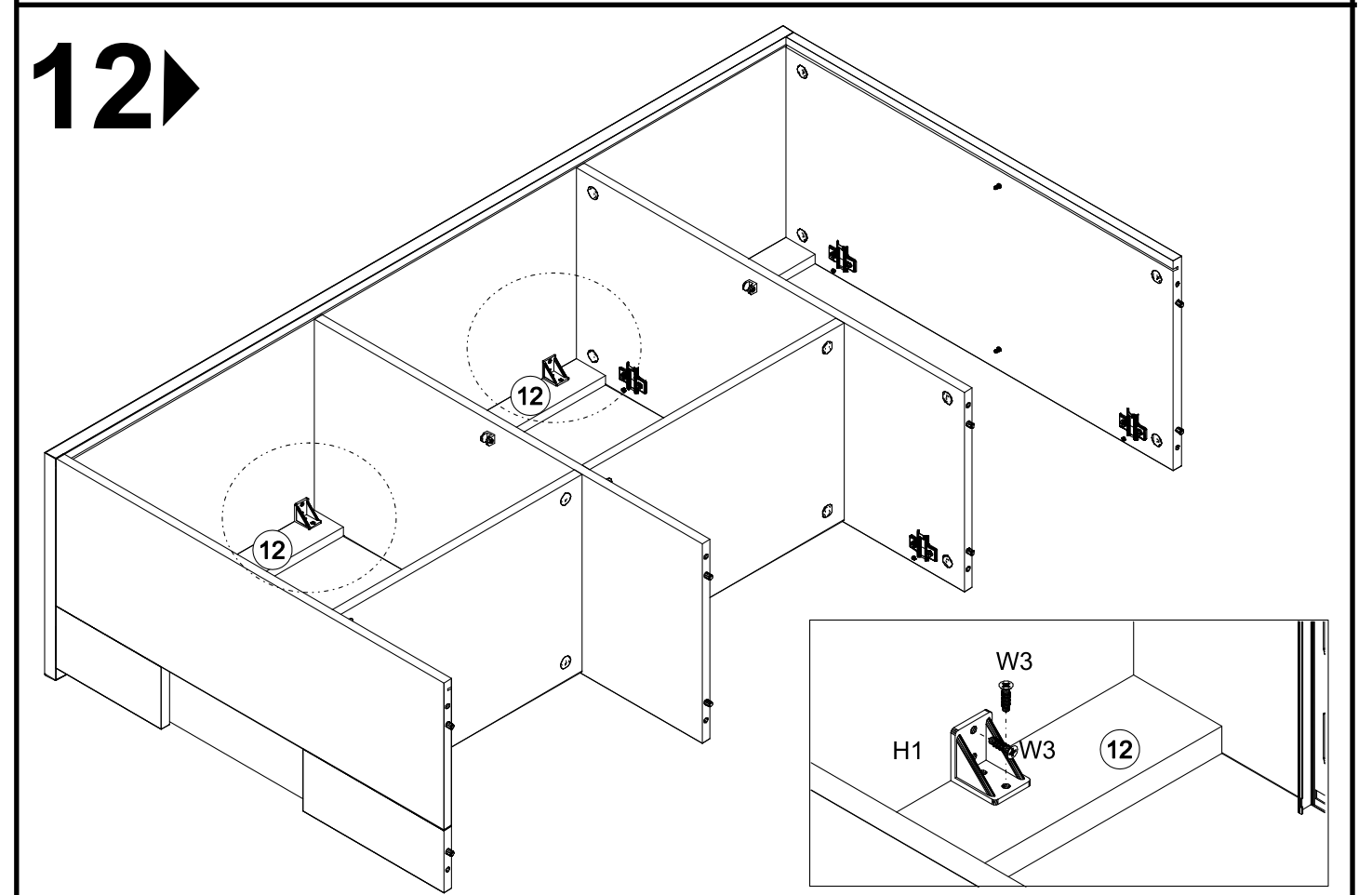
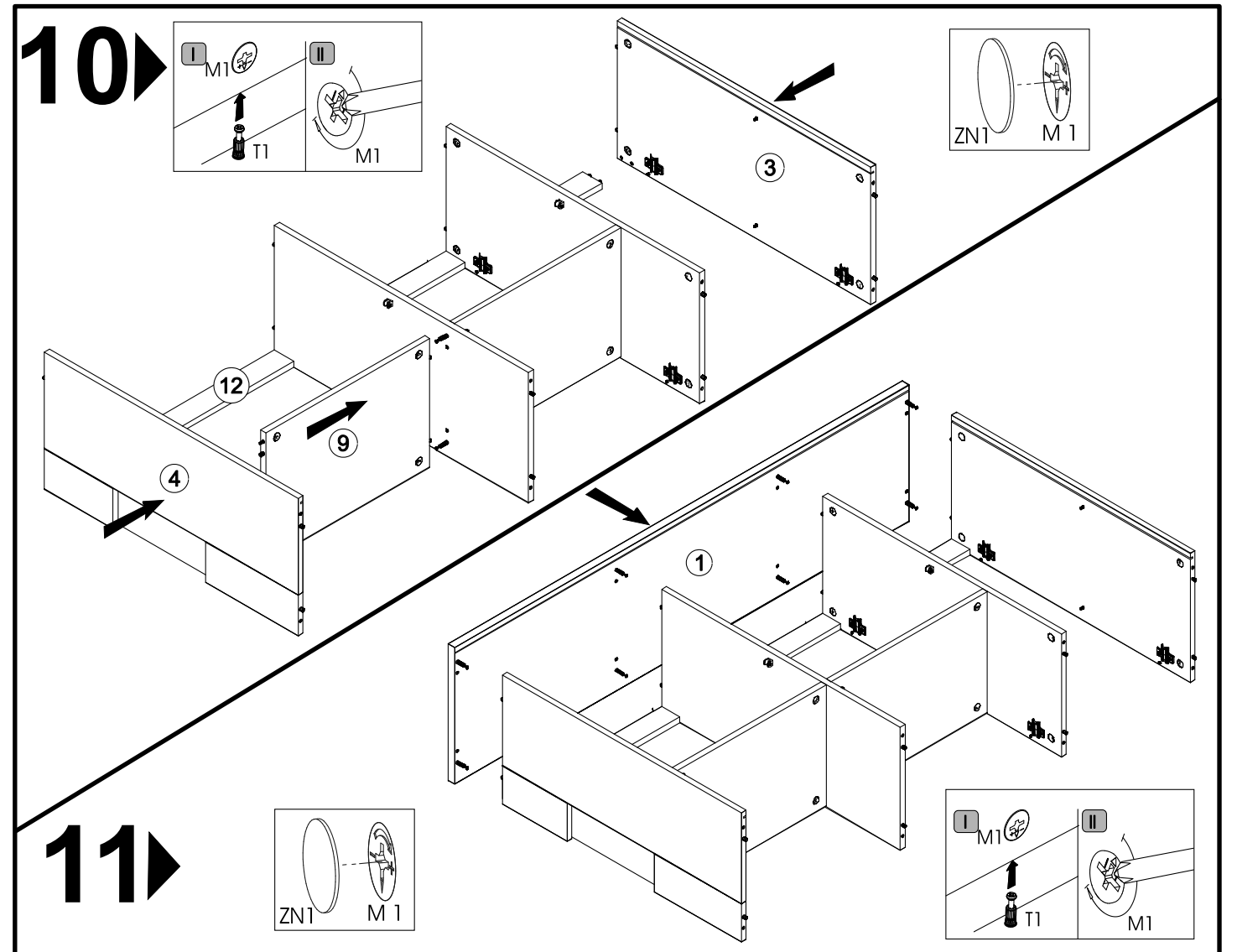
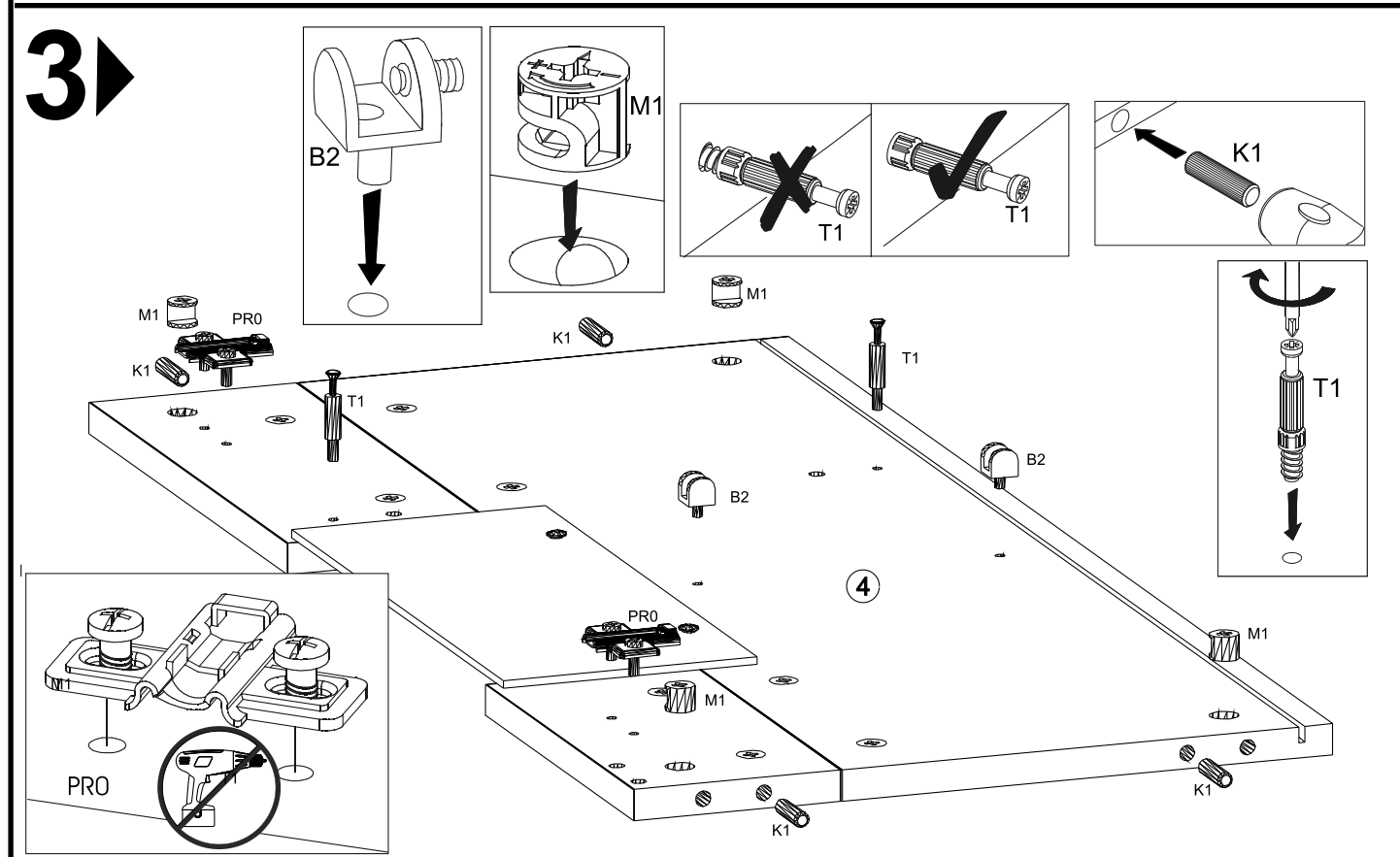
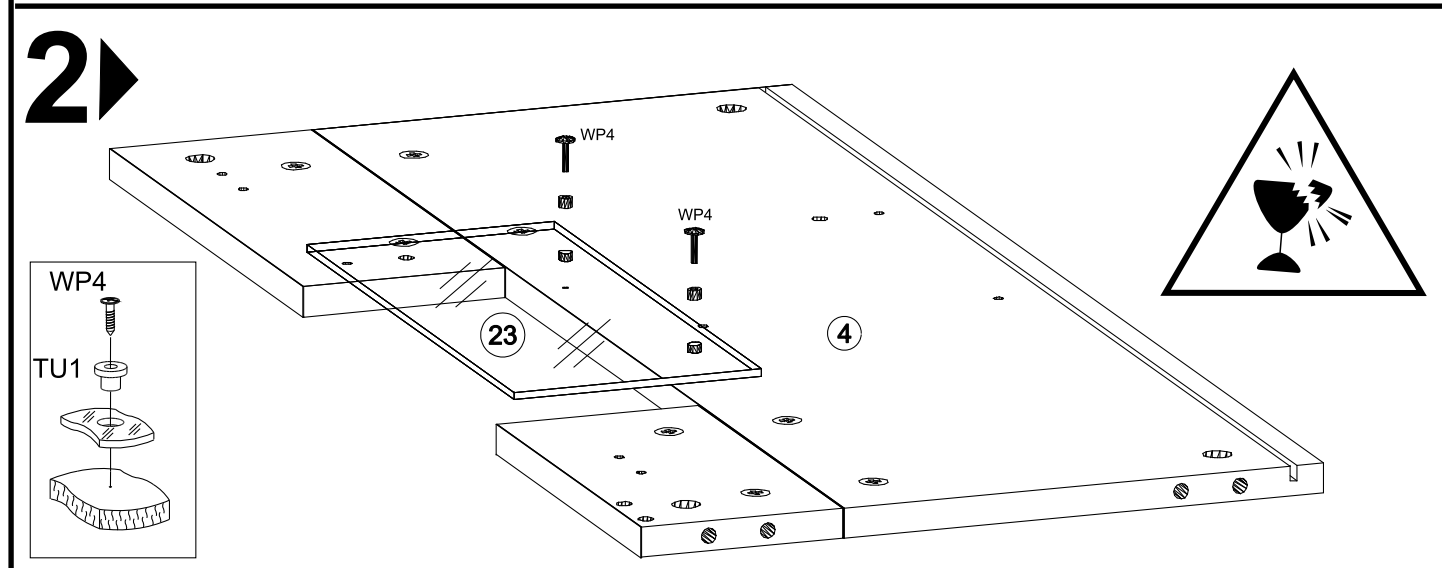
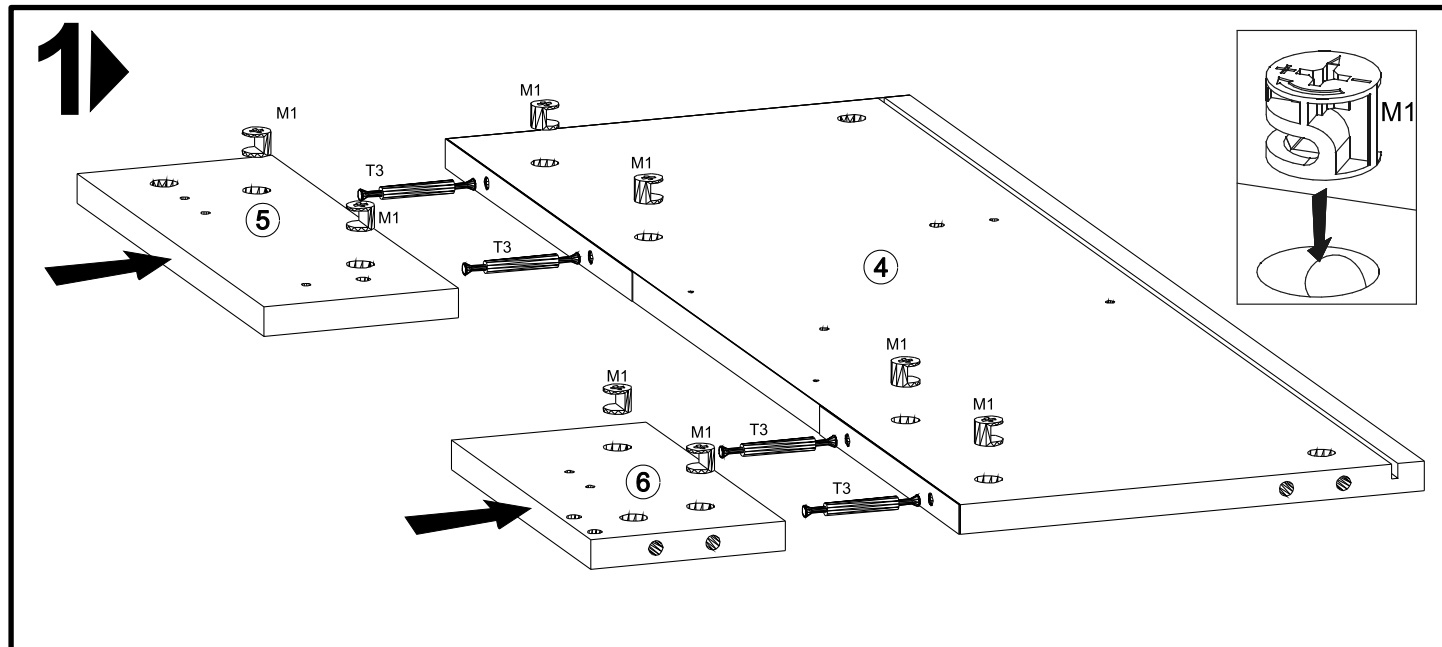



4

PR4

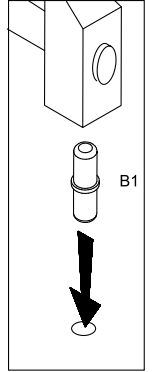
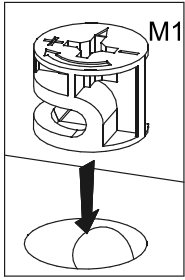
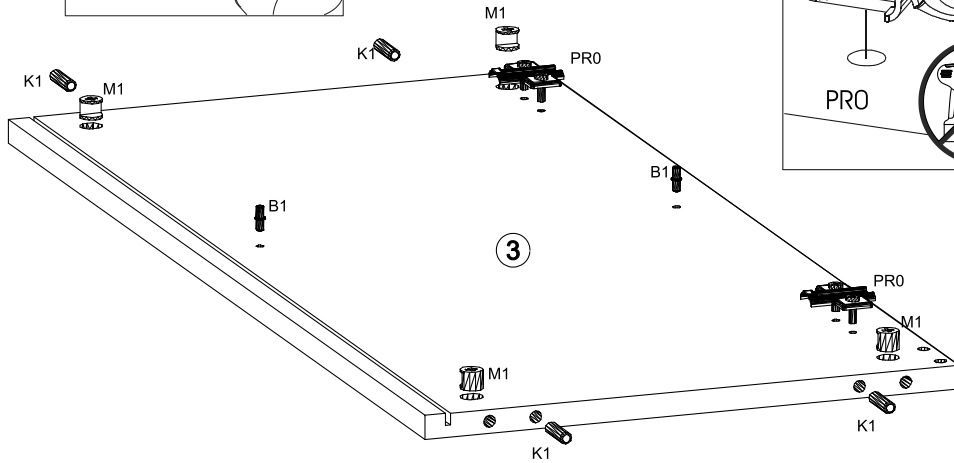
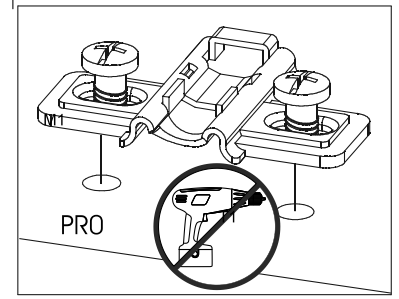
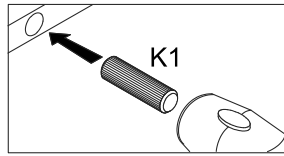

5

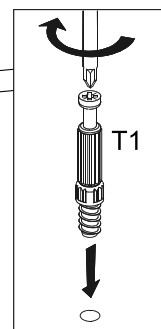
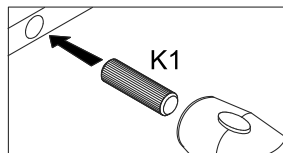
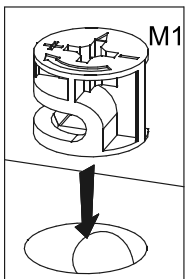
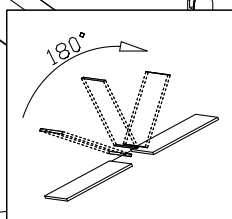
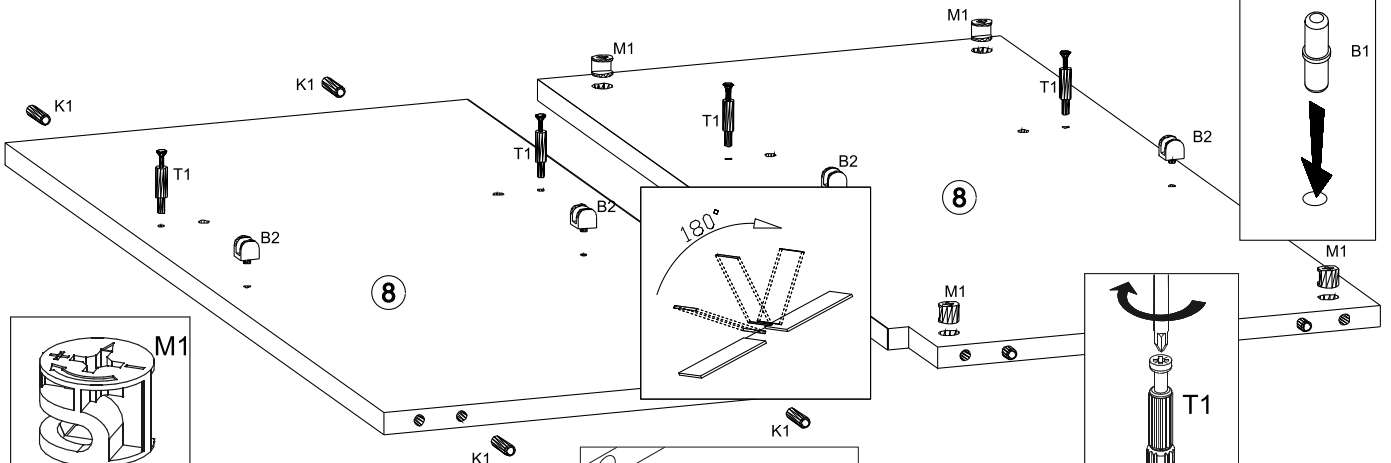
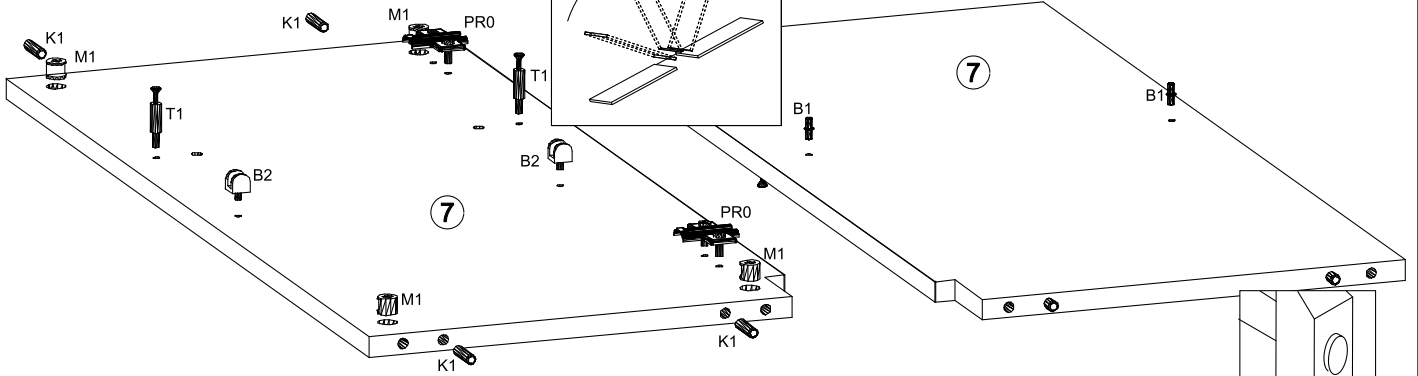
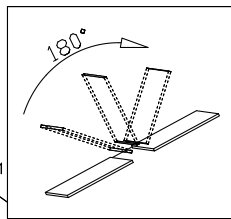
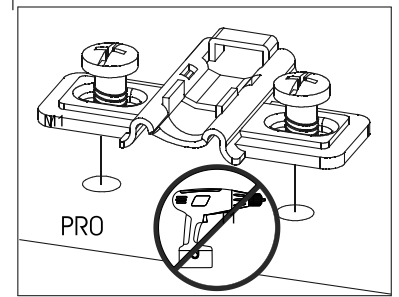
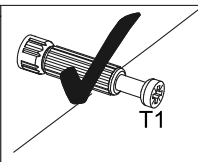
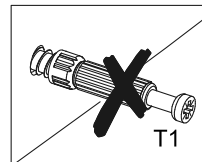
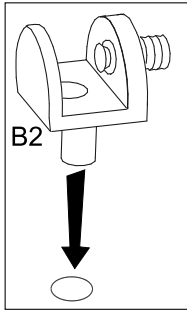

# 6▶

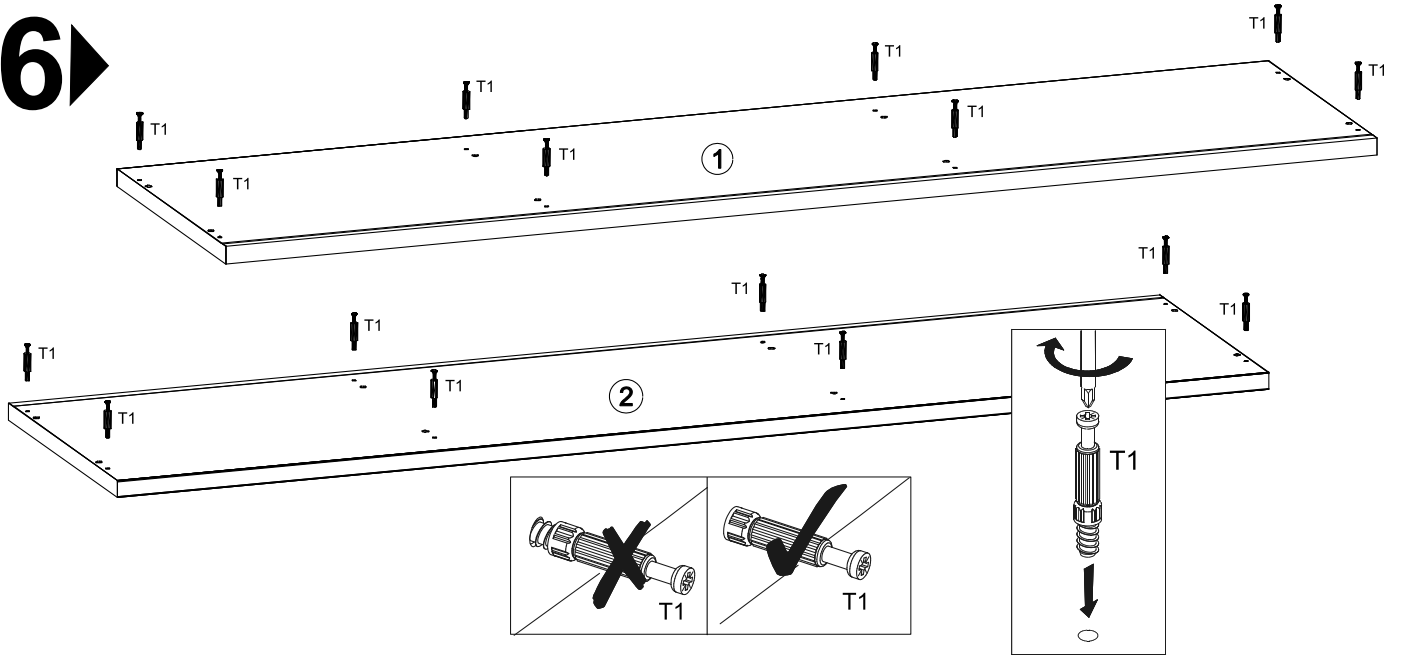

# 7▶

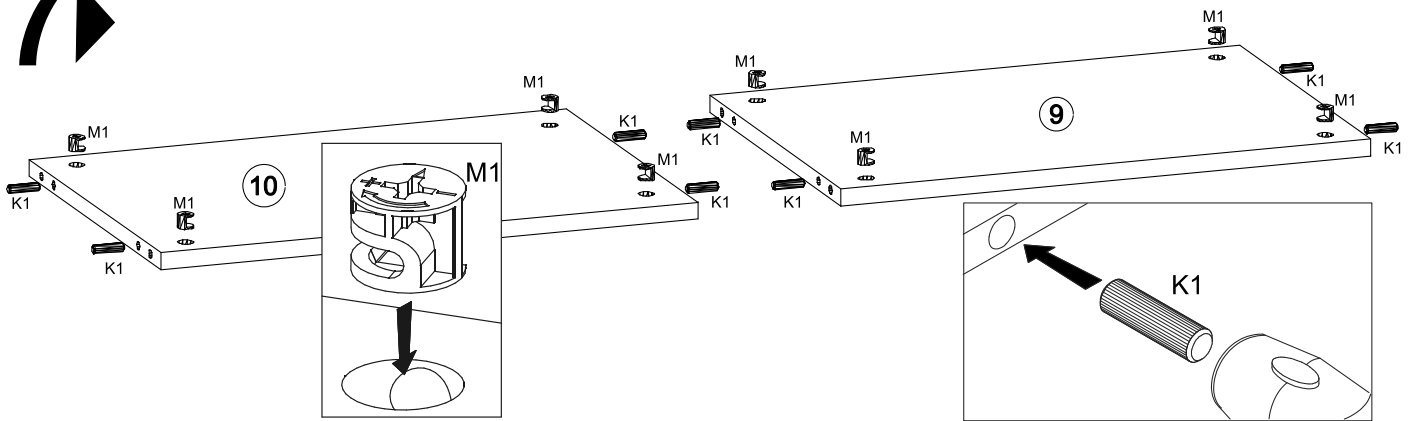

# 8▶

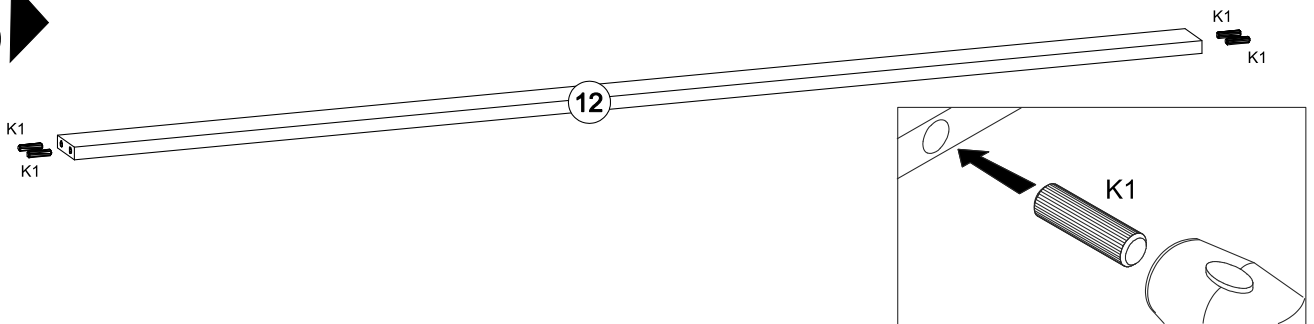

# 9▶

