

9

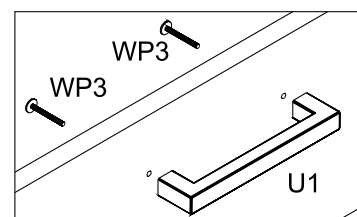

MODELL: NE 07

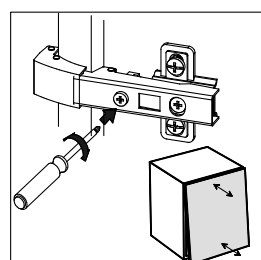
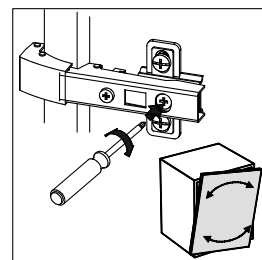
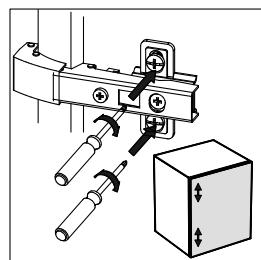
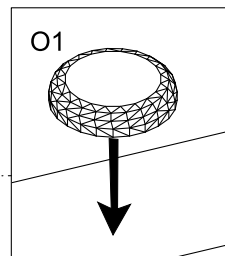
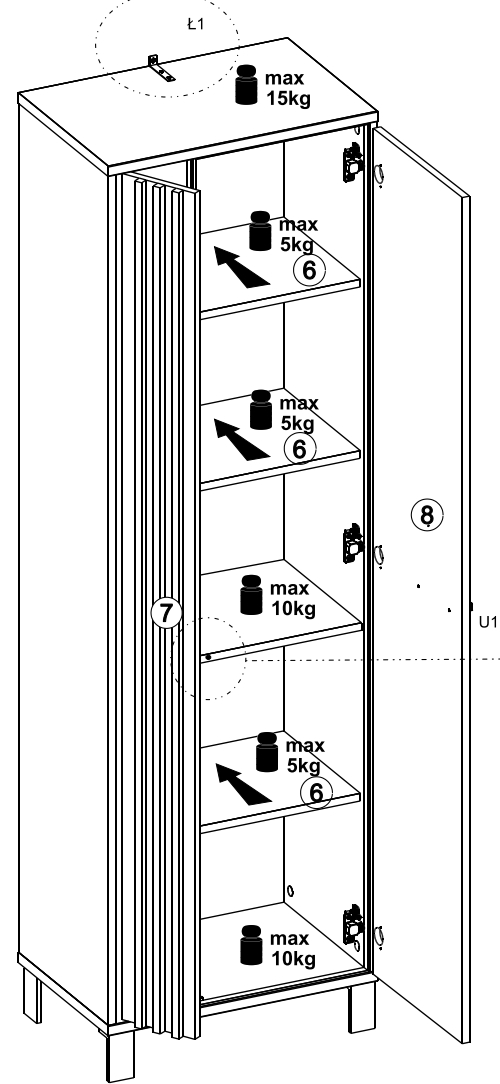
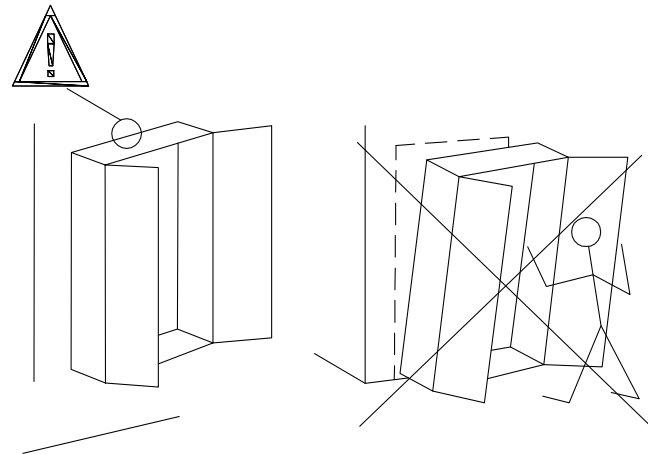
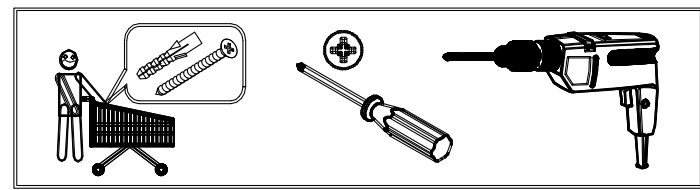
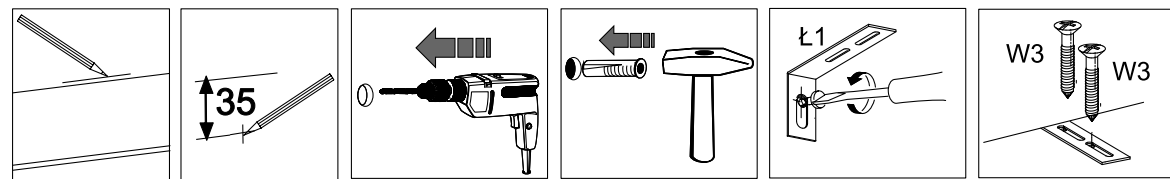
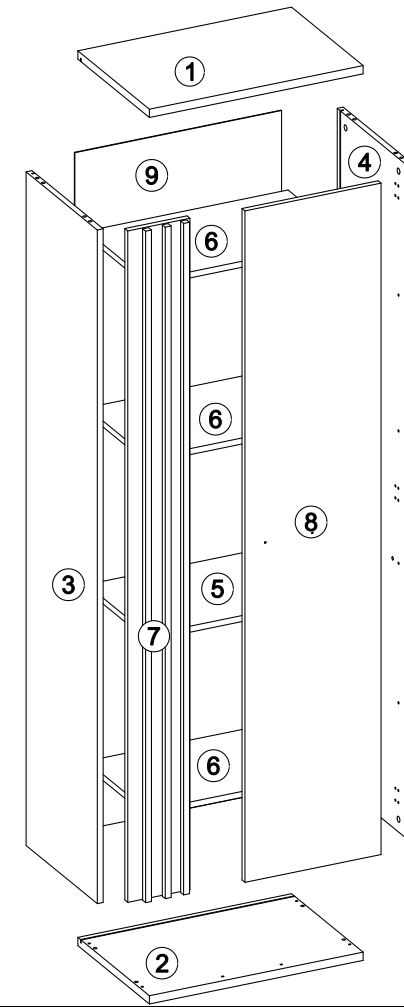
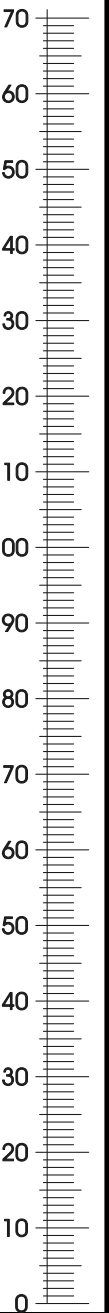
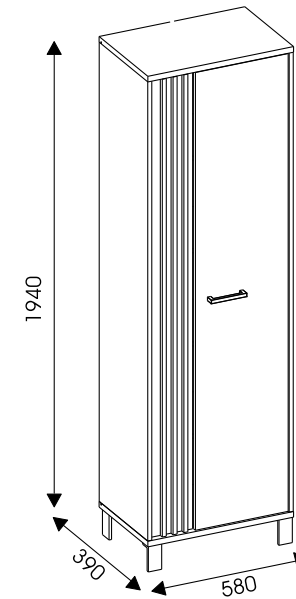
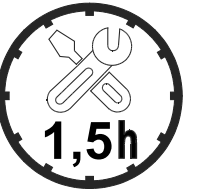
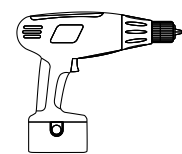
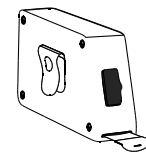
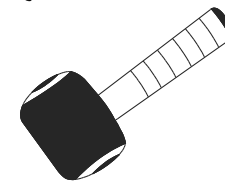
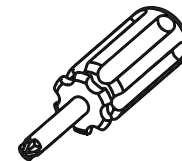
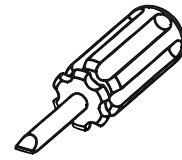
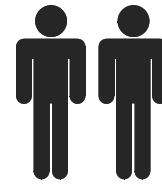
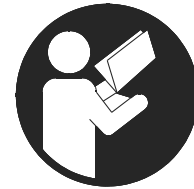

| | | |
|---|----------|-----|
| 9 | 1808x562 | 2/2 |
| 8 | 1788x370 | 2/2 |
| 7 | 1788x169 | 2/2 |
| 6 | 547x330 | 1/2 |
| 5 | 548x334 | 1/2 |
| 4 | 1794x387 | 2/2 |
| 3 | 1794x387 | 2/2 |
| 2 | 581x389 | 1/2 |
| 1 | 581x389 | 1/2 |

| | | | | | | | | |
|------------------|-------------------|------------|-----------------------|---------------------|---------------------|-------------------|-------------------|-----------|
| 1x #1.5 O1 | 2x B2 | 12x ST1 | 14x #20/863 ZN1 | 14x 3.5x16 W3 | 12x 3x20 W9 | 6x H=2 PR1 | 2x 4x30 WP3 | 4x N1 |
| 6x ZC1 | 12x 8x30 K1 | 1x U 1 | 1x LK008121S L1 | 12x #15/15 M1 | 12x DU232T T1 | 16x 5x20 W5 | 3x 2x20 G1 | 12x B1 |

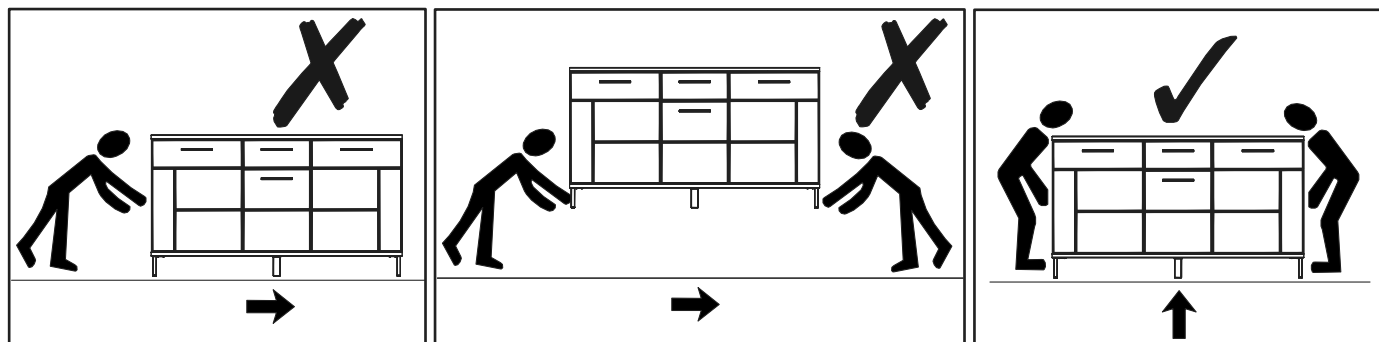
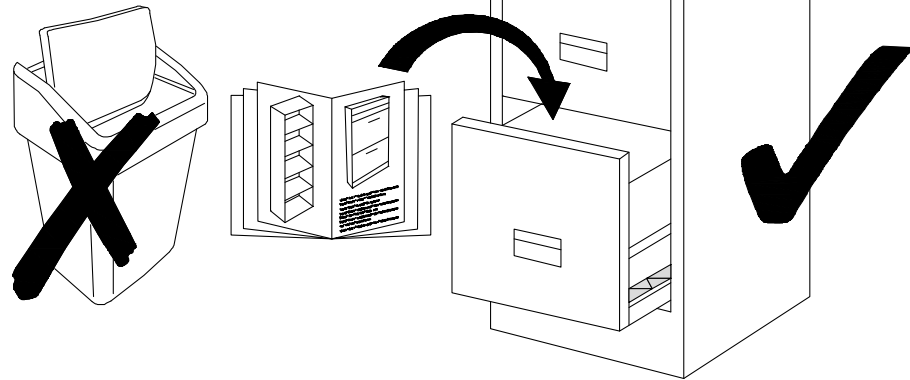

8

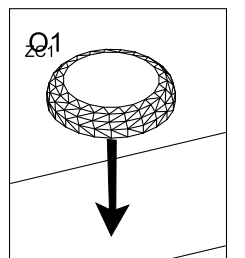
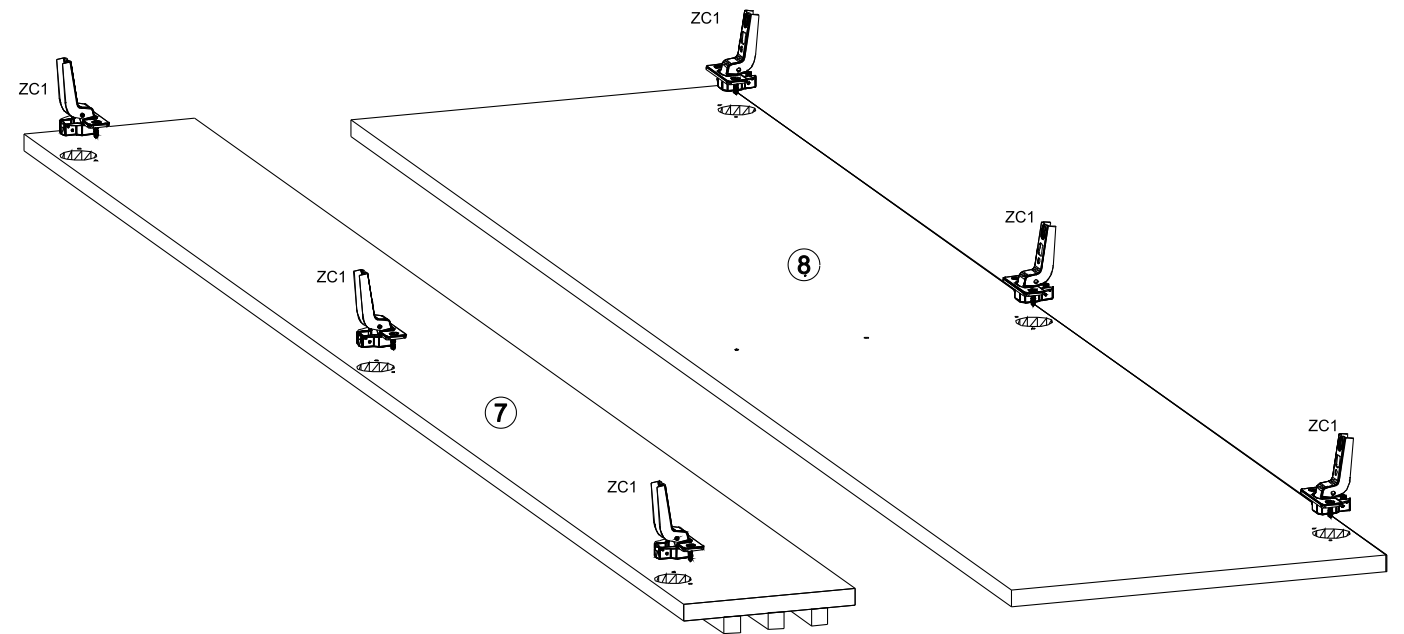
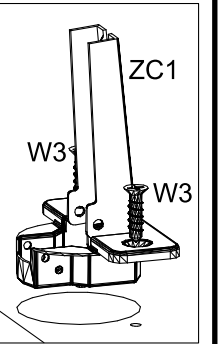

7 NE 07

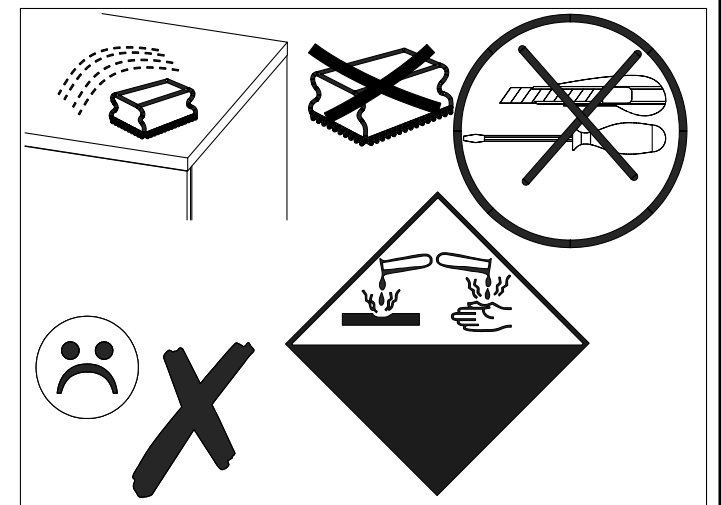
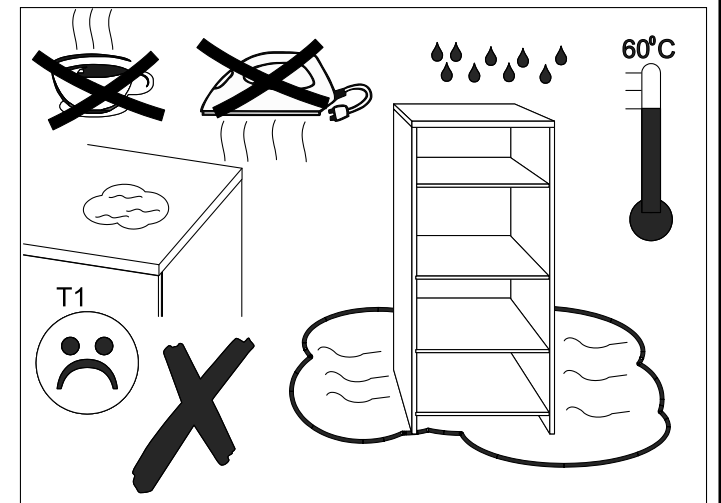
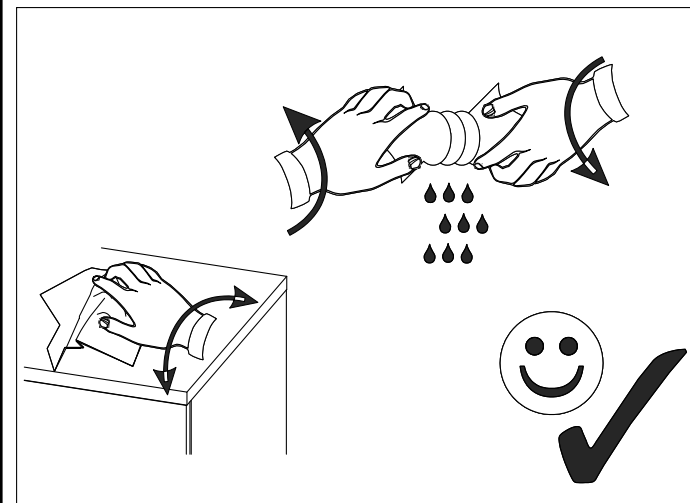
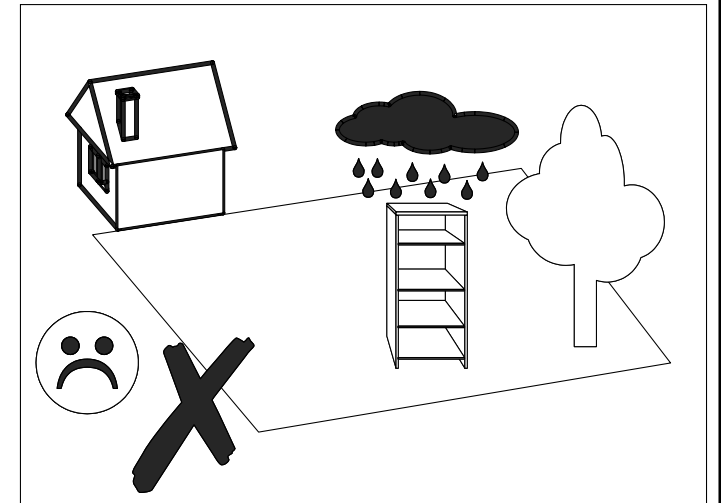
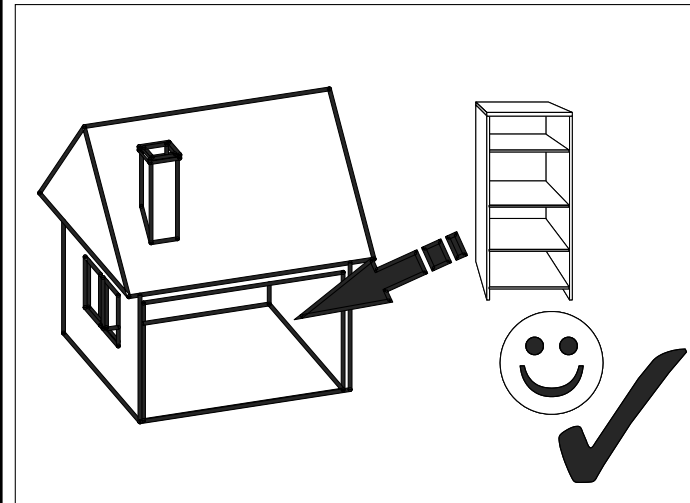
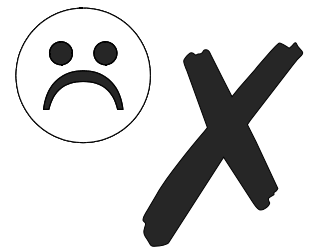
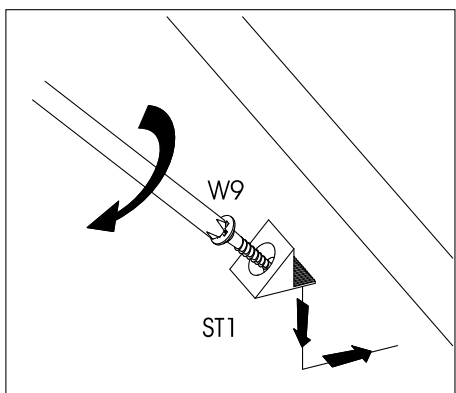
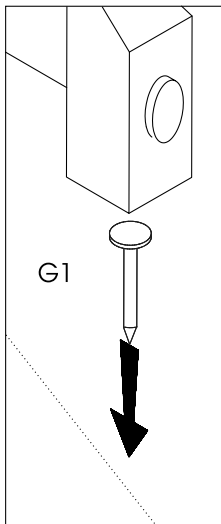
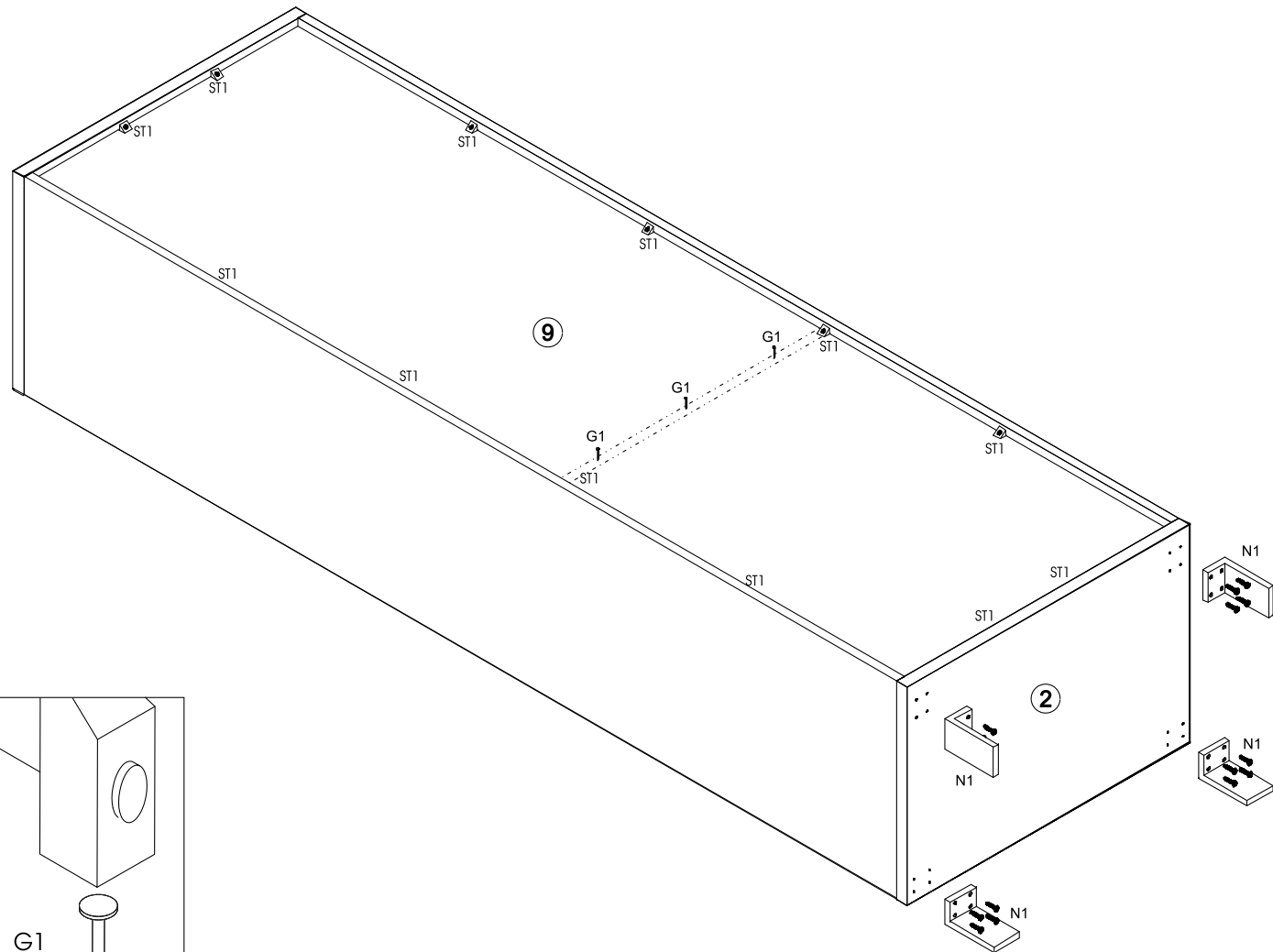
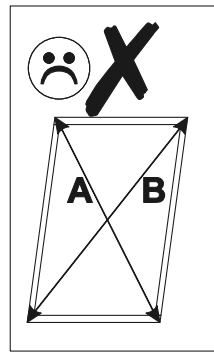
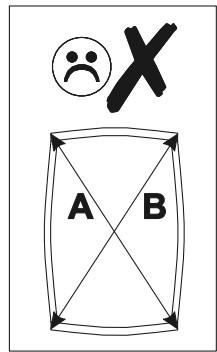
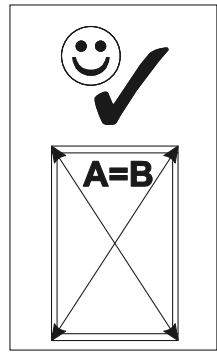

1▶

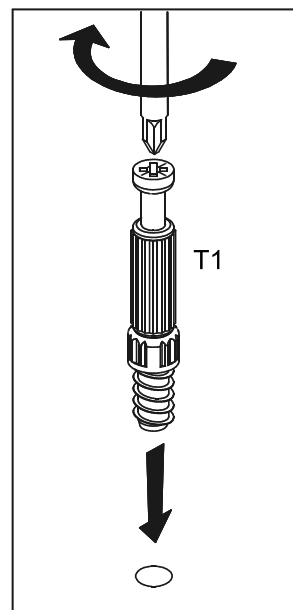
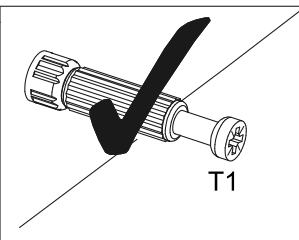
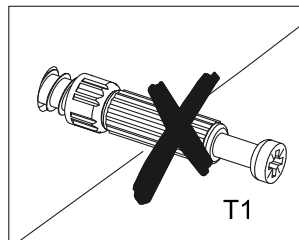
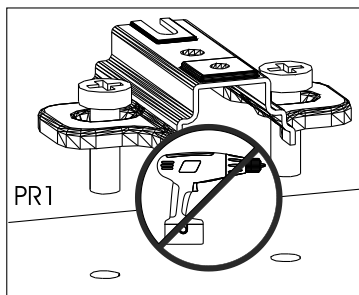
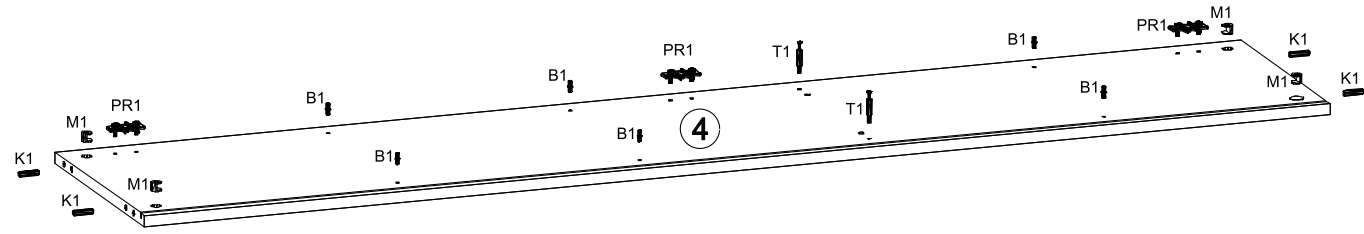
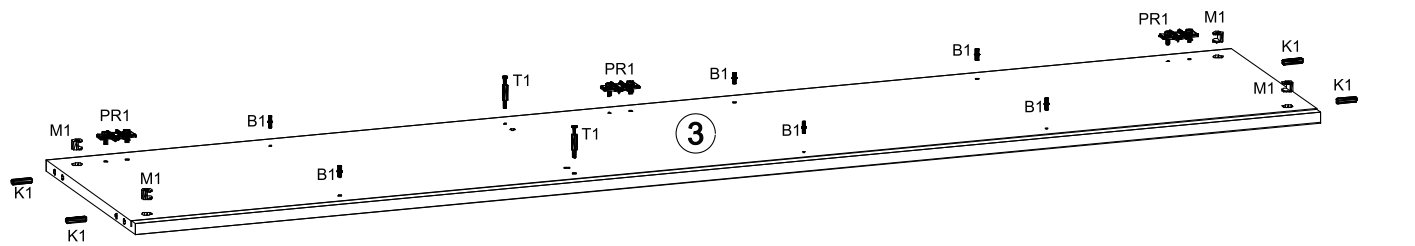
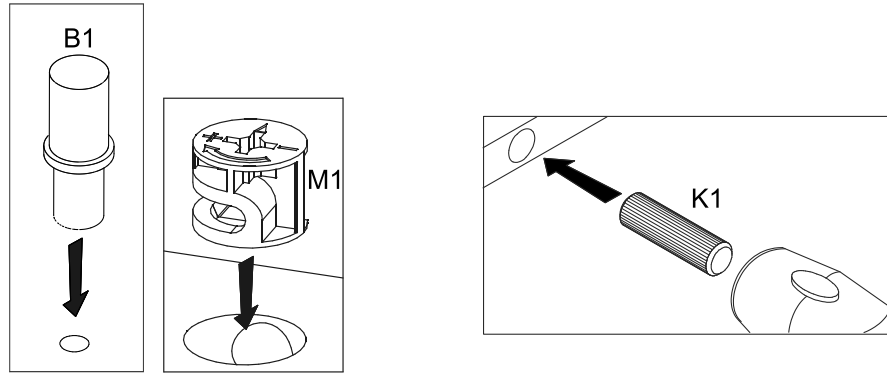

5▶

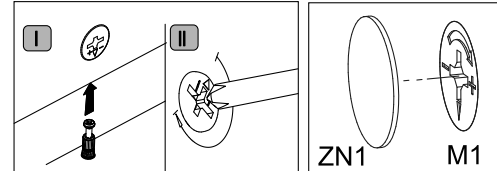
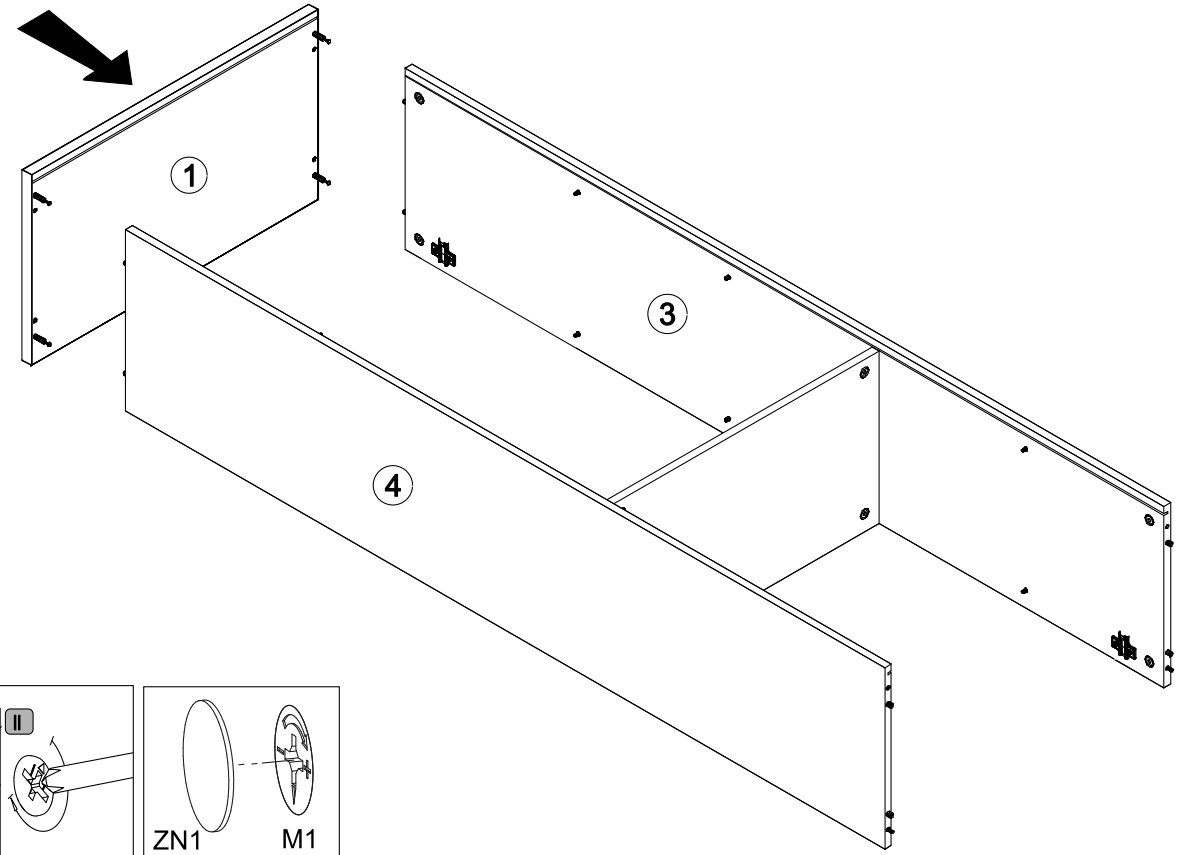

6▶

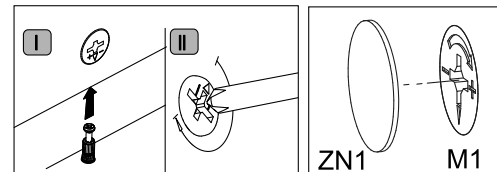
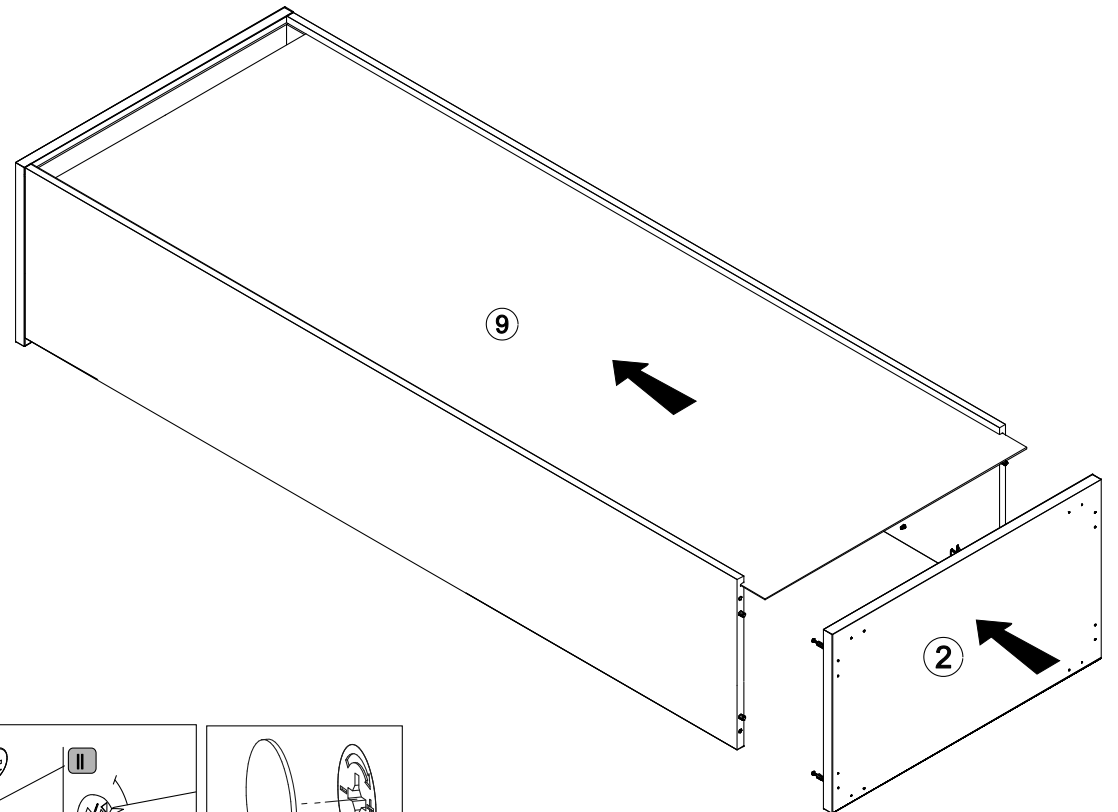

2▶

NE 07

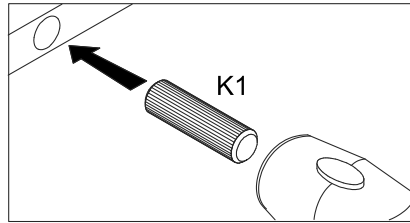
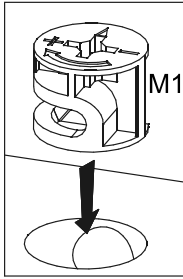
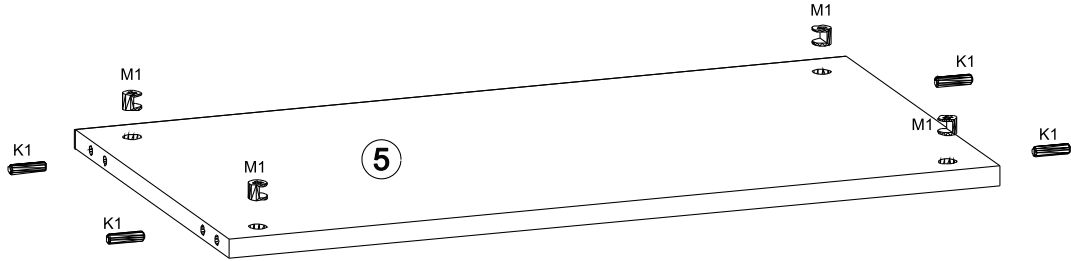

3▶

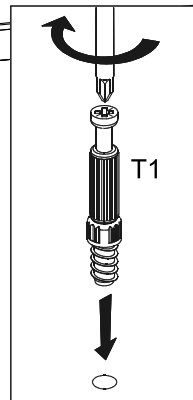
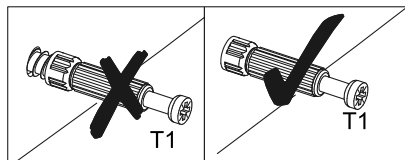
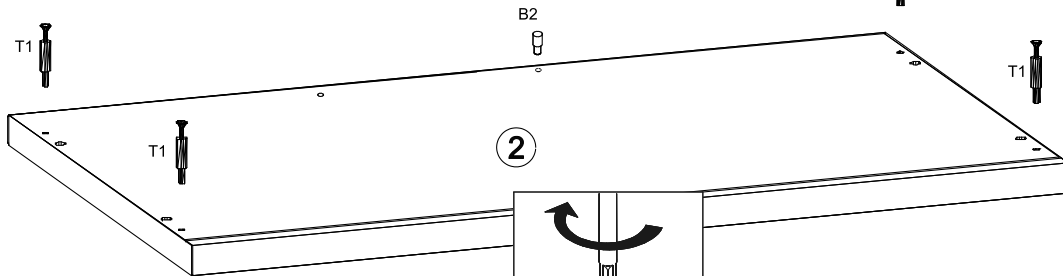
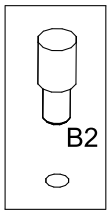
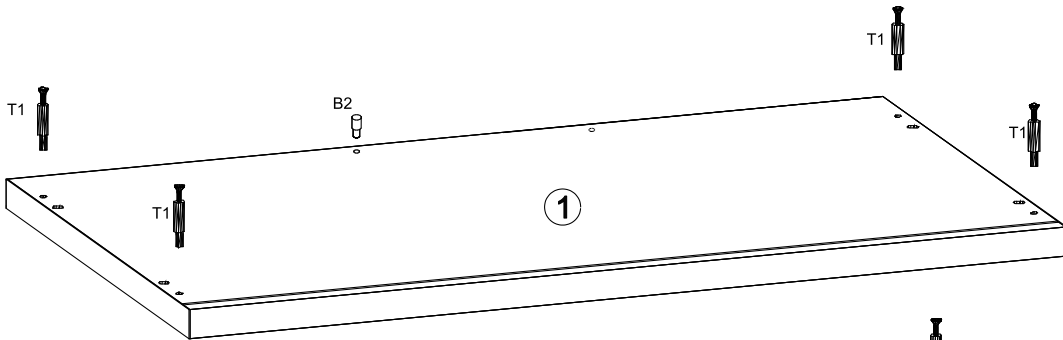

4 ▶

