

18

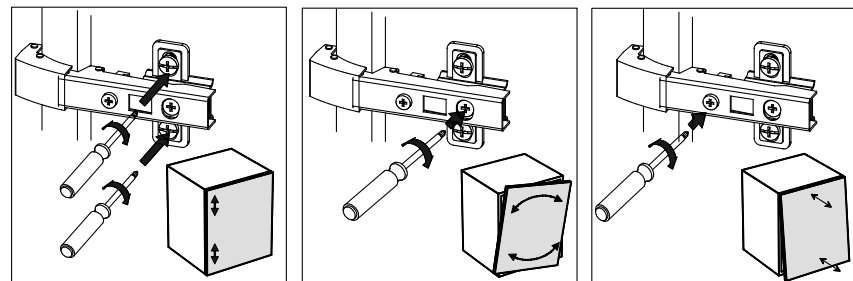

MODELL: MR8

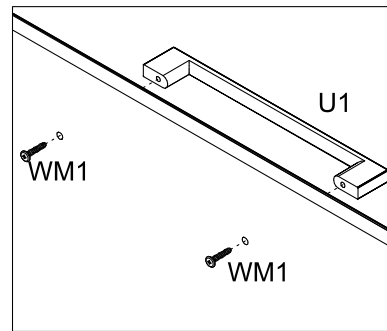
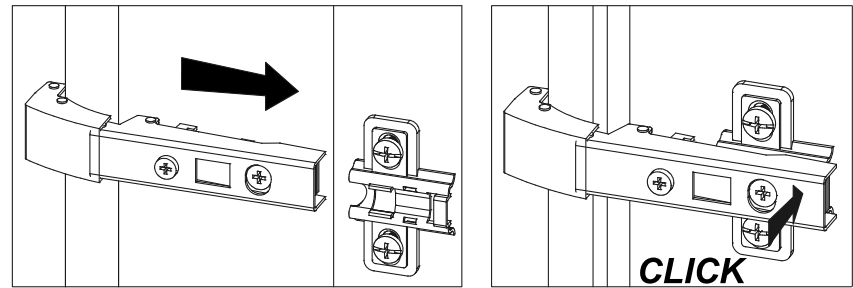
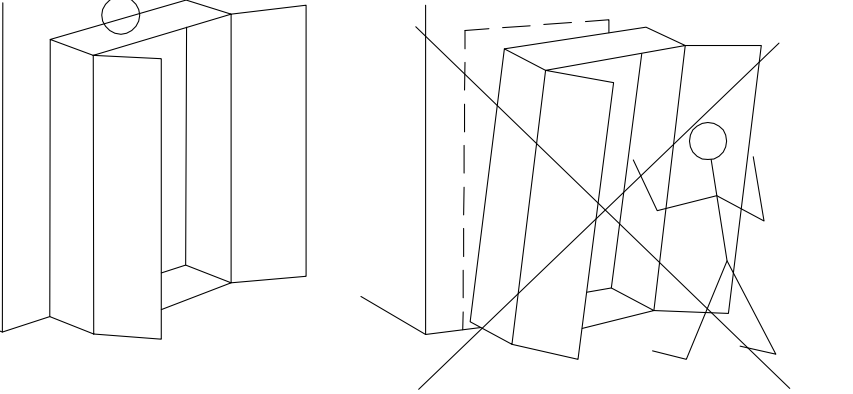
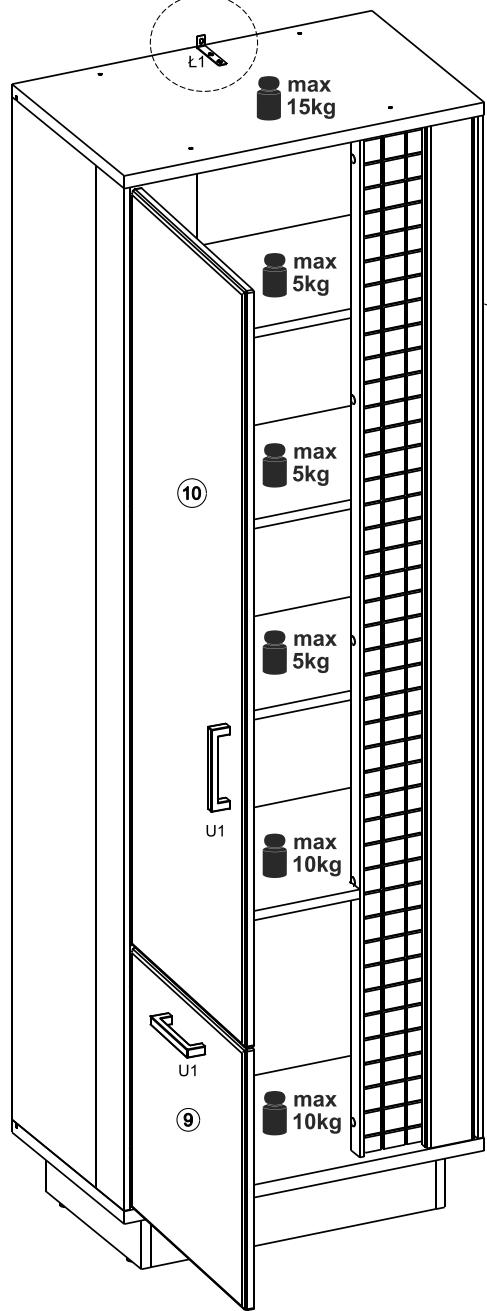
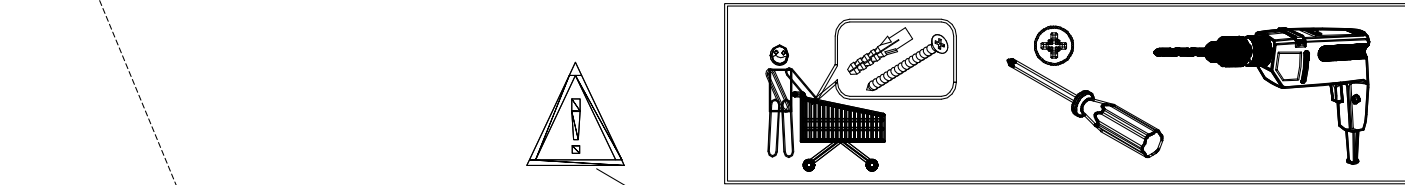
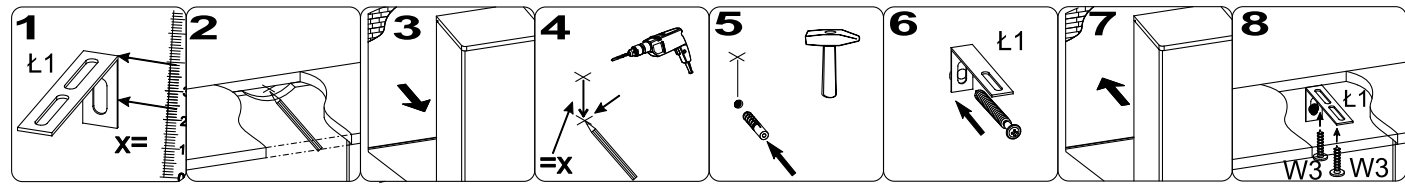
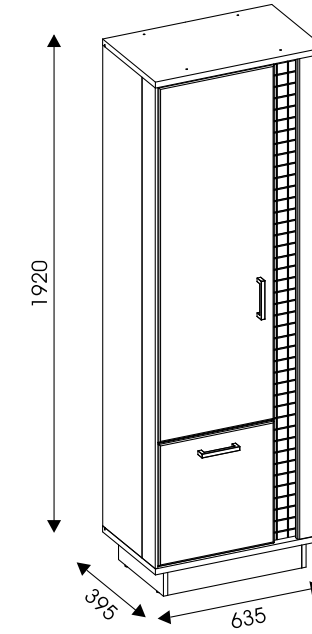
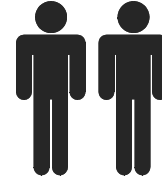
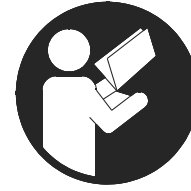

16	616x1782	2/3
15	503x104	3/3
14	337x104	3/3
13	1767x86	2/3
12	1767x32	2/3
11	1767x118	2/3
10	1307x436	3/3
9	436x451	3/3
8	601x325	1/3
7	602x358	1/3
6	1767x99	2/3
5	1767x295	2/3
4	1767x99	2/3
3	1767x295	2/3
2	635x396	1/3
1	635x396	1/3

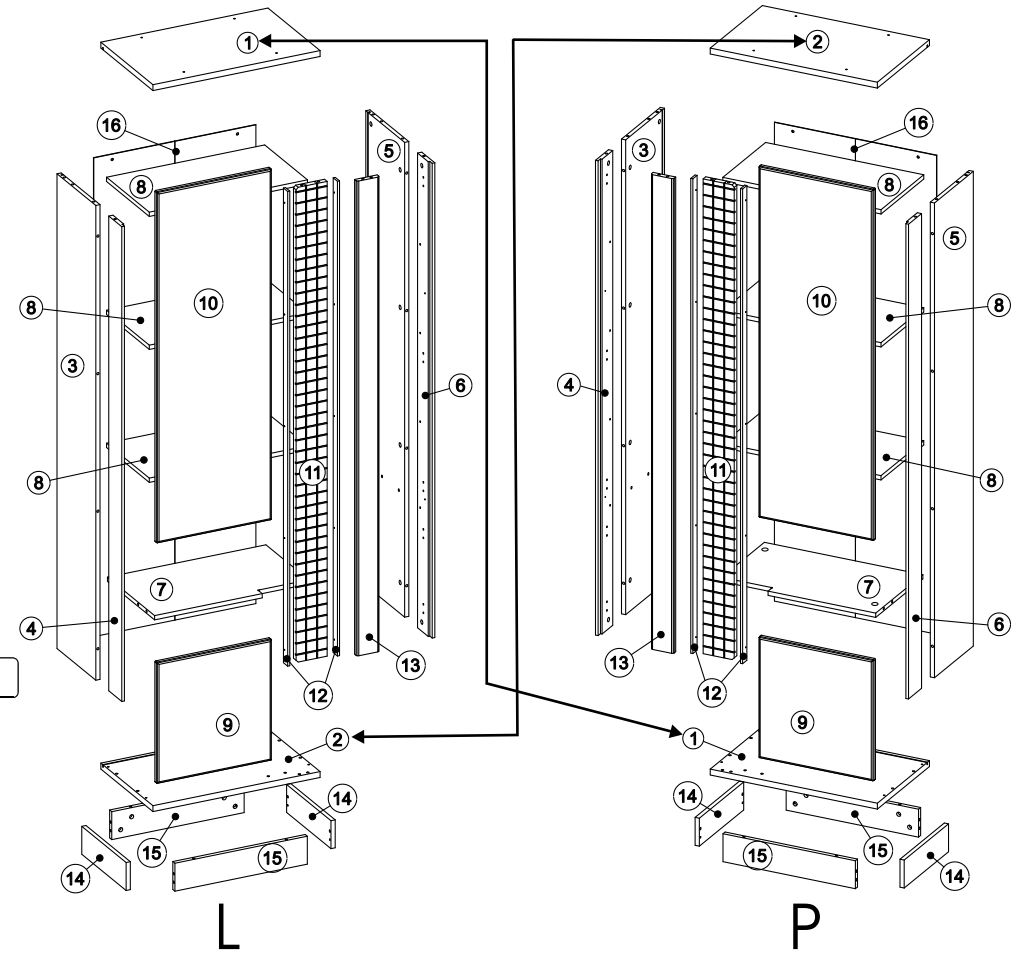
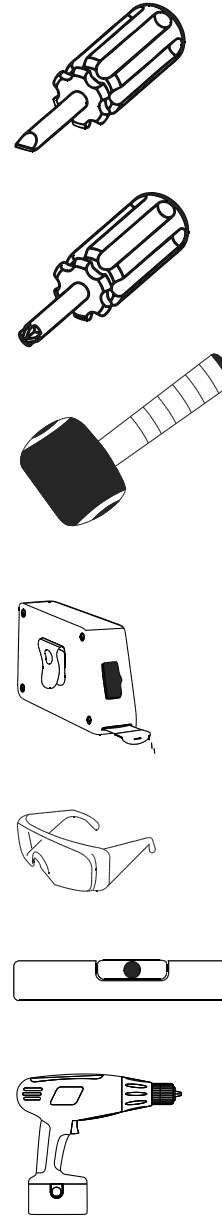
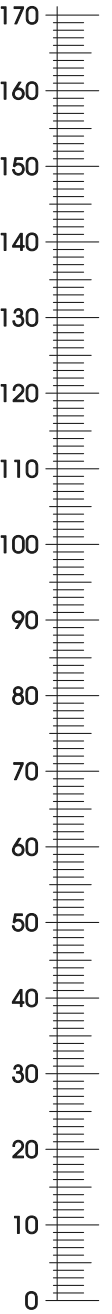

4x	16x	12x	5x	10x	12x	5x	2x	4x
#20/325	ZN2	3.5x16	W3	ST1	ZC8	3x25	W10	3x20
							W9	H=2
							PR2	U1
								N1
5x	24x	12x	2x	28x	28x	4x	16x	4x
#14/112	ZN3	8x30	K1	B1	Z10	#15/15	M1	DU232T
								T1
								4x30
								WM1
								#20/112
								ZN1
								2x20
								G1

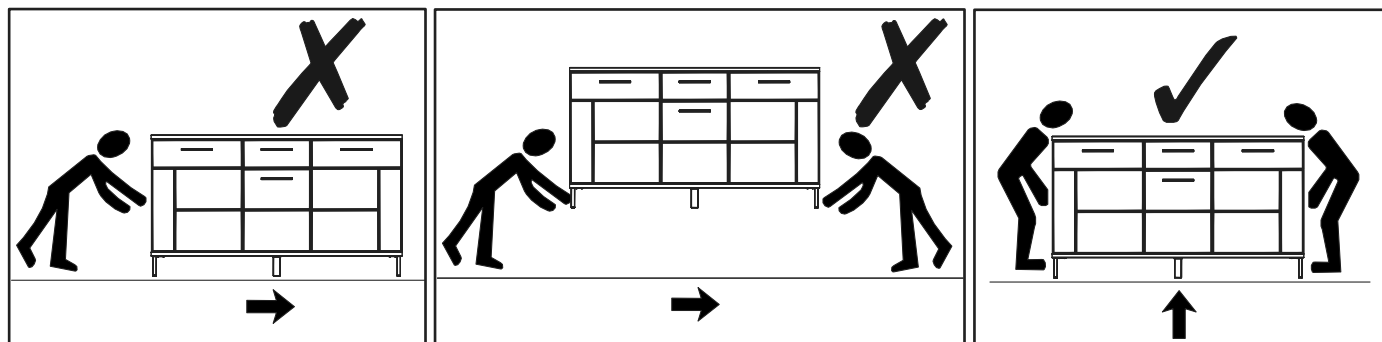
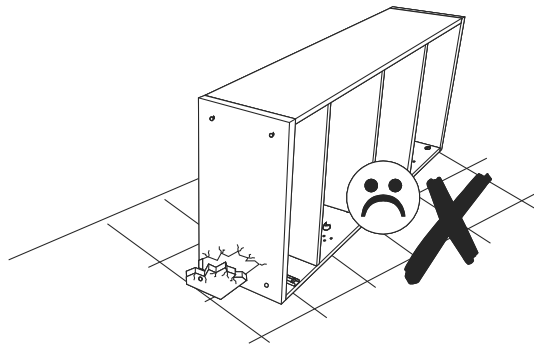
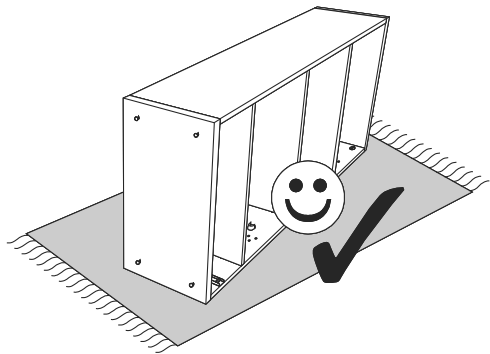
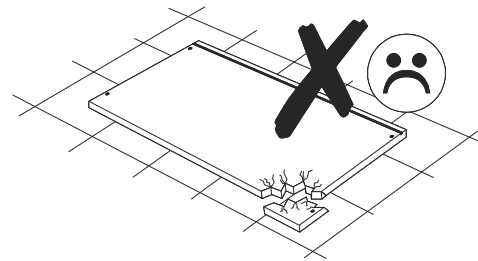
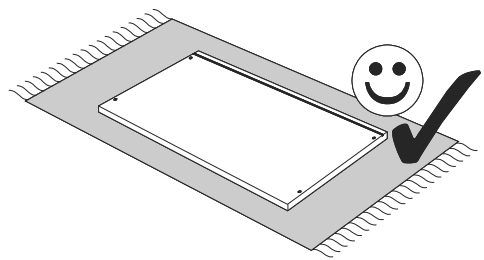
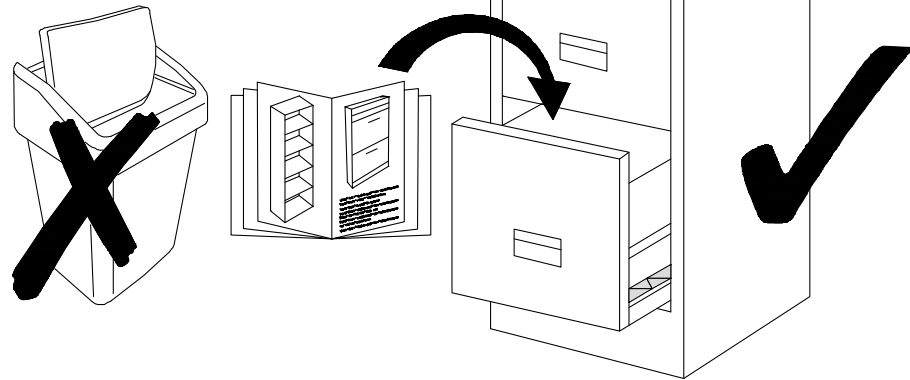

16▶

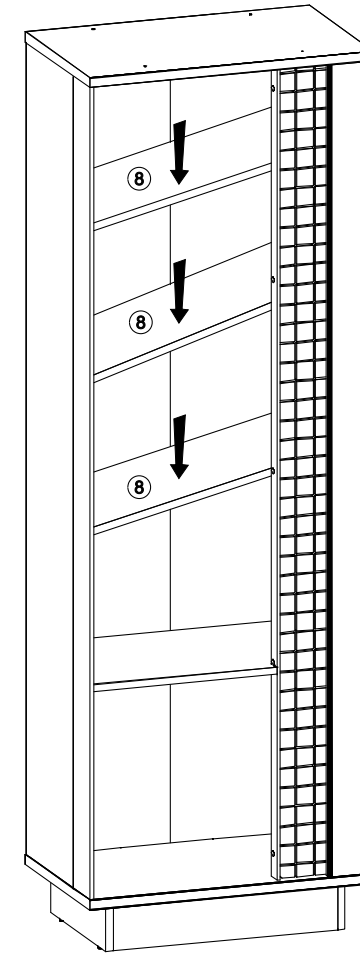

17▶

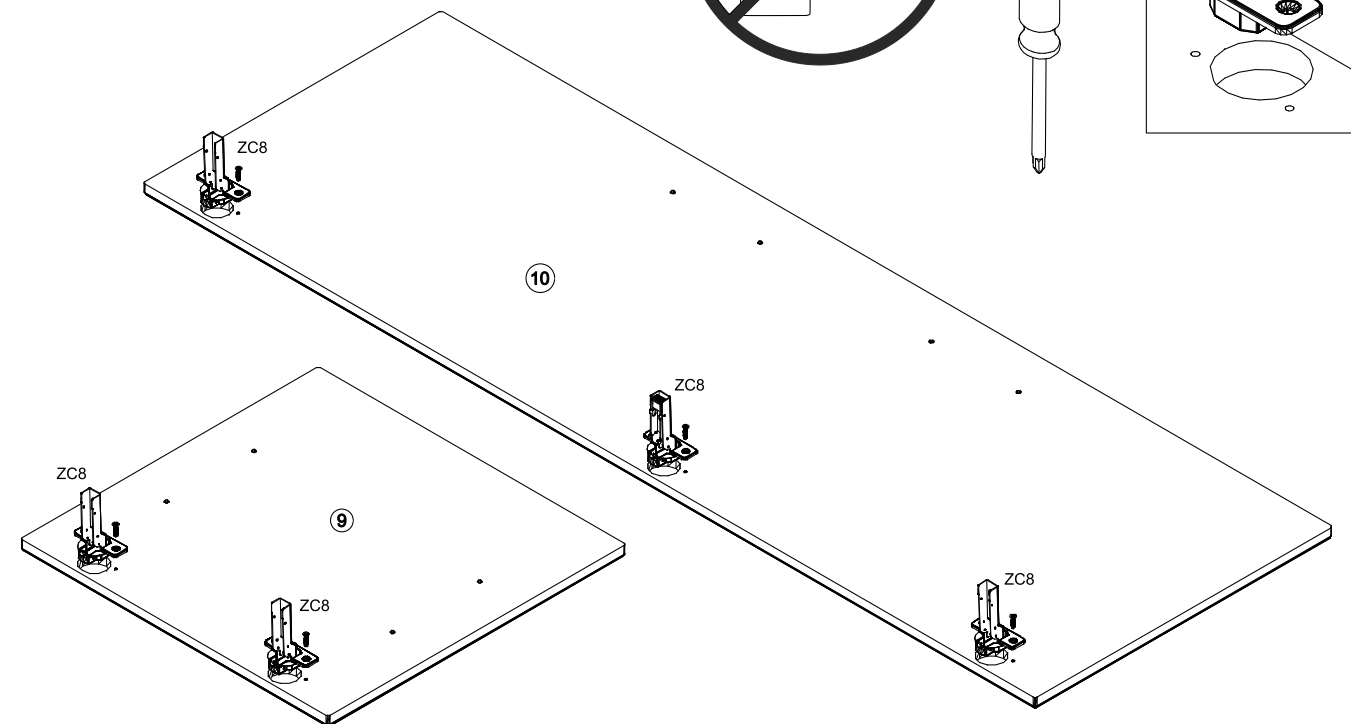
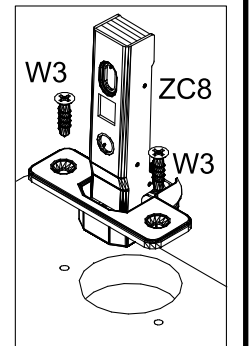
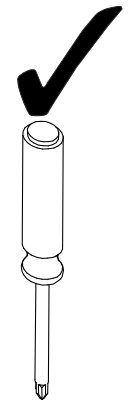
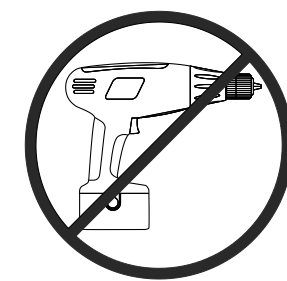

14

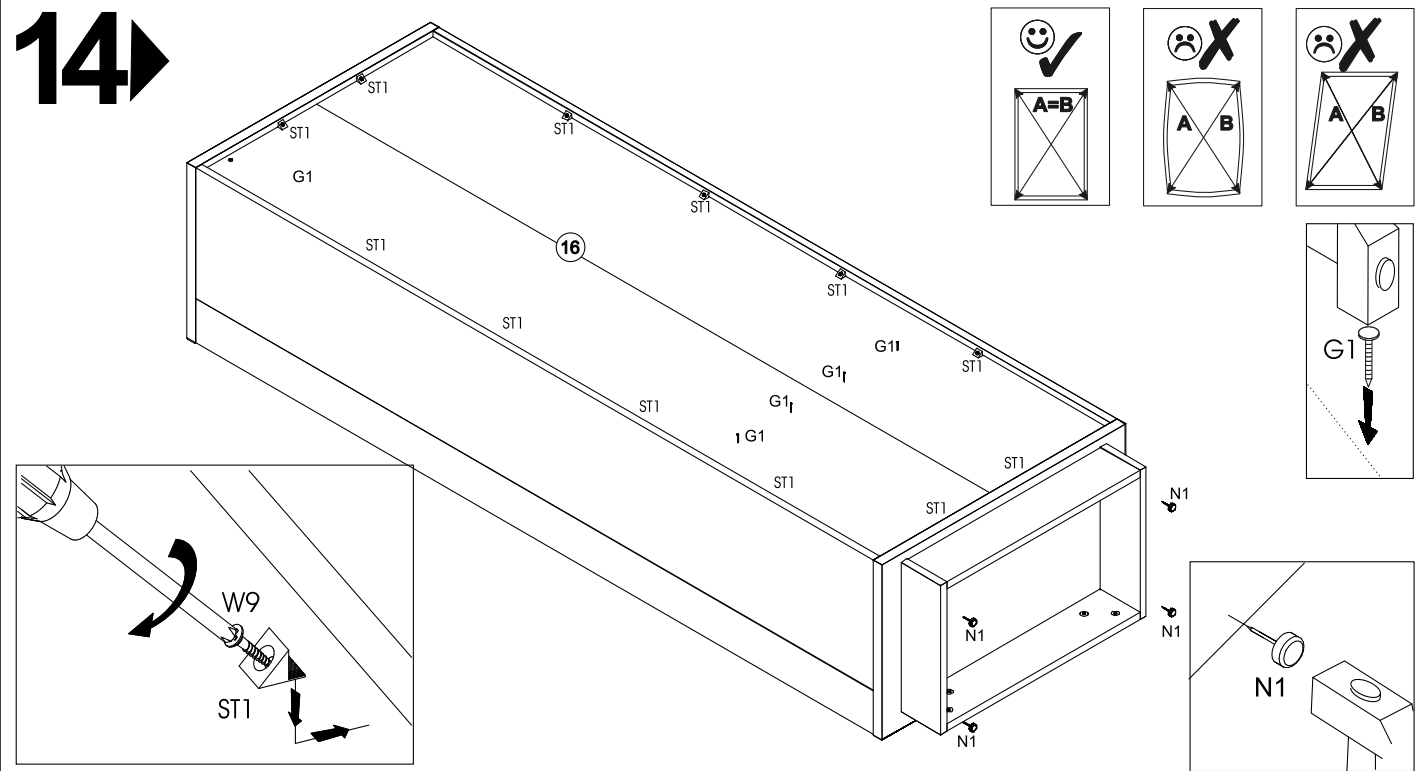

15

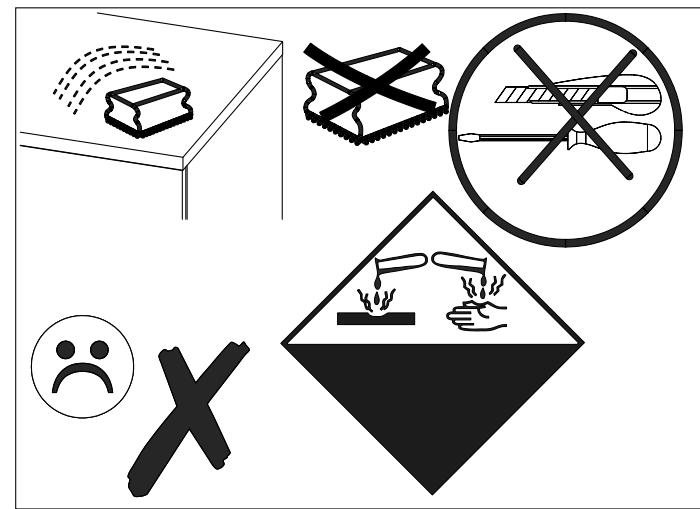
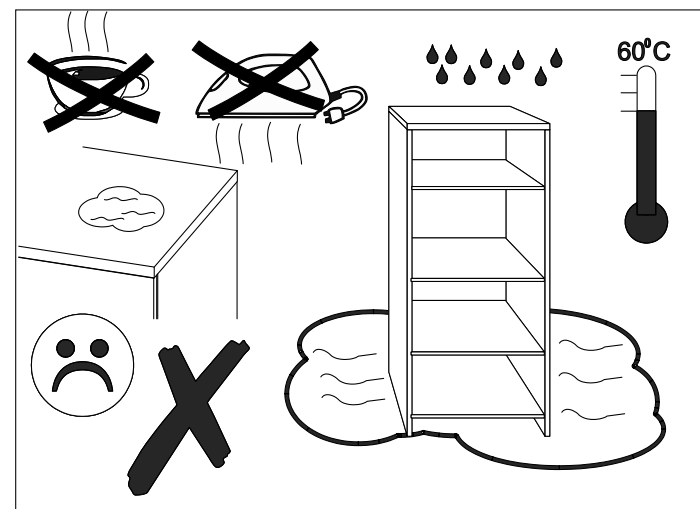
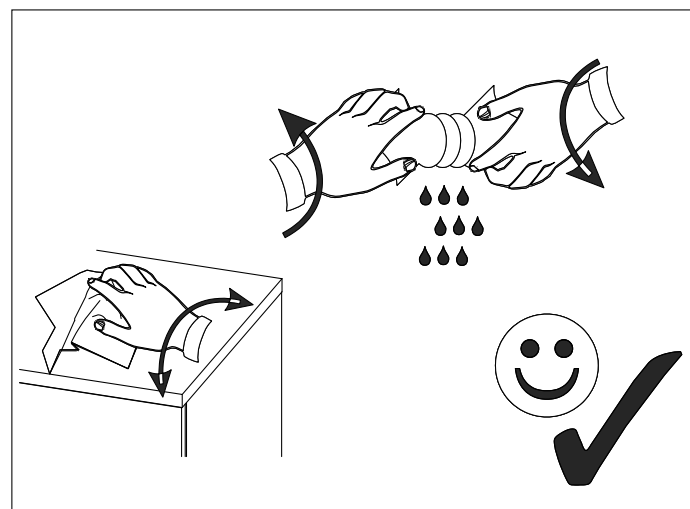
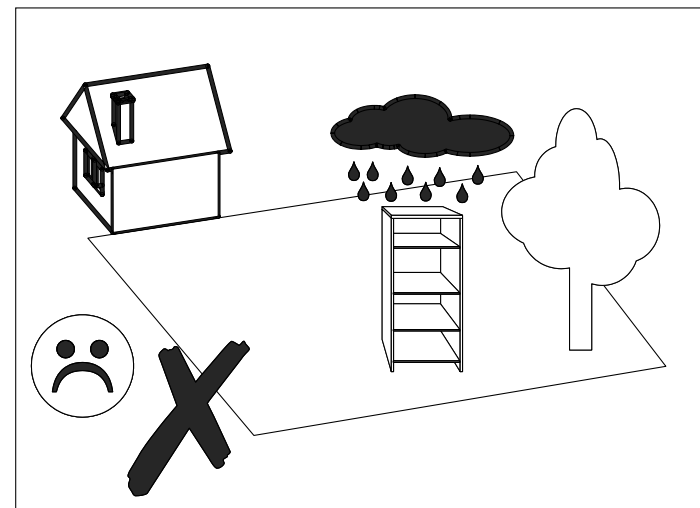
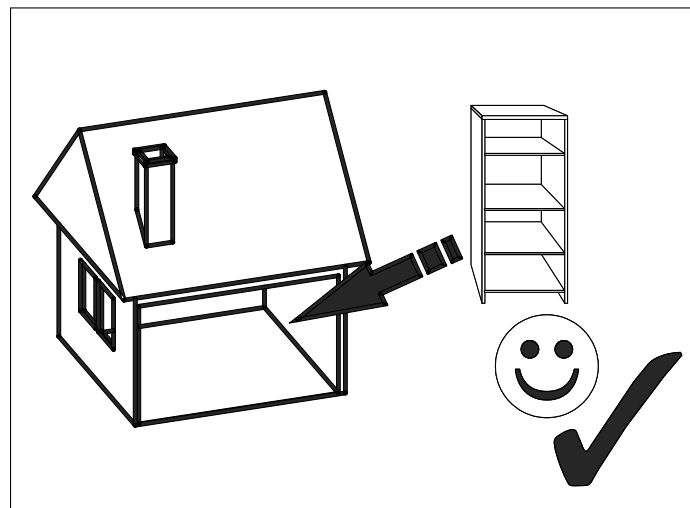
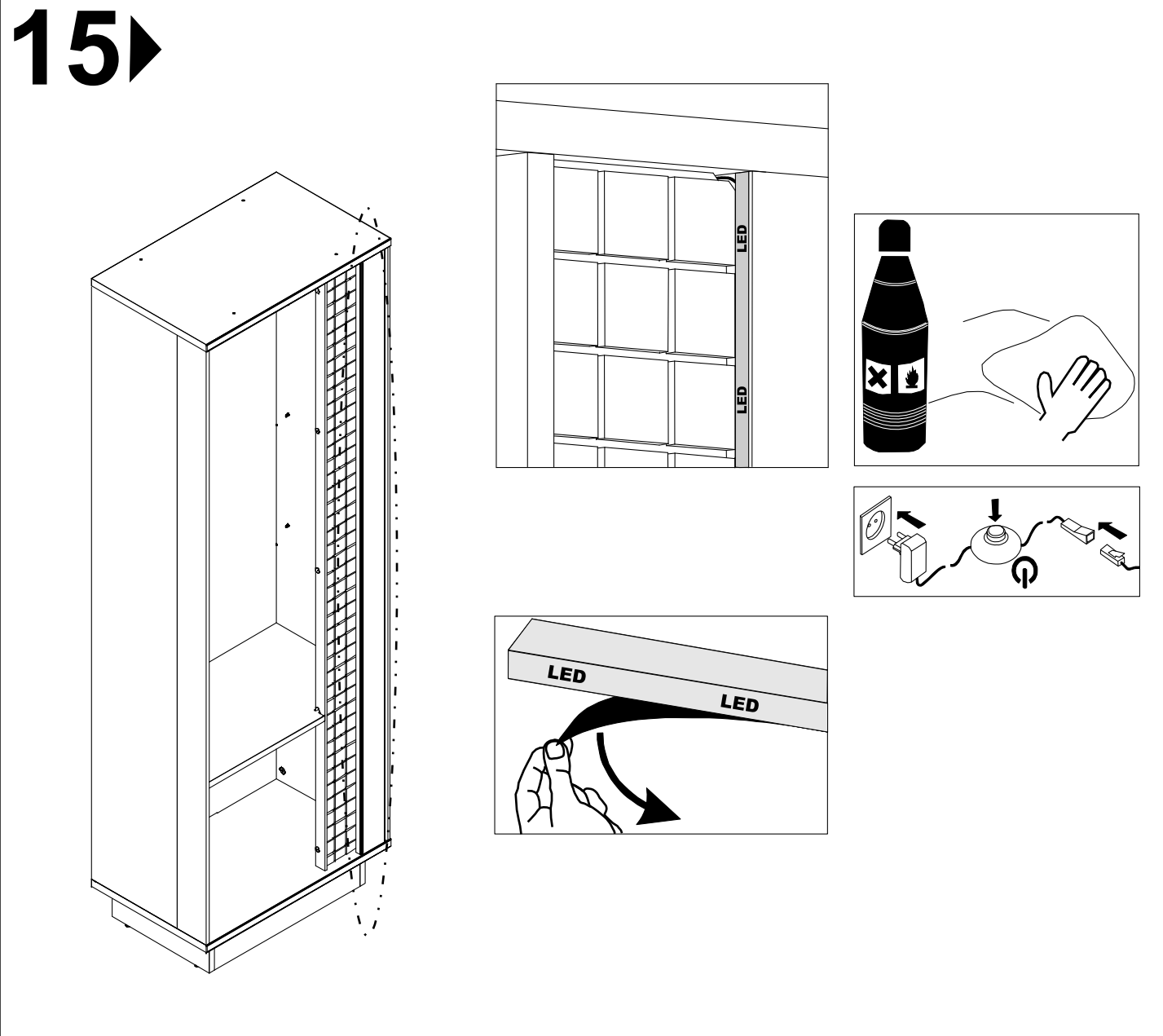

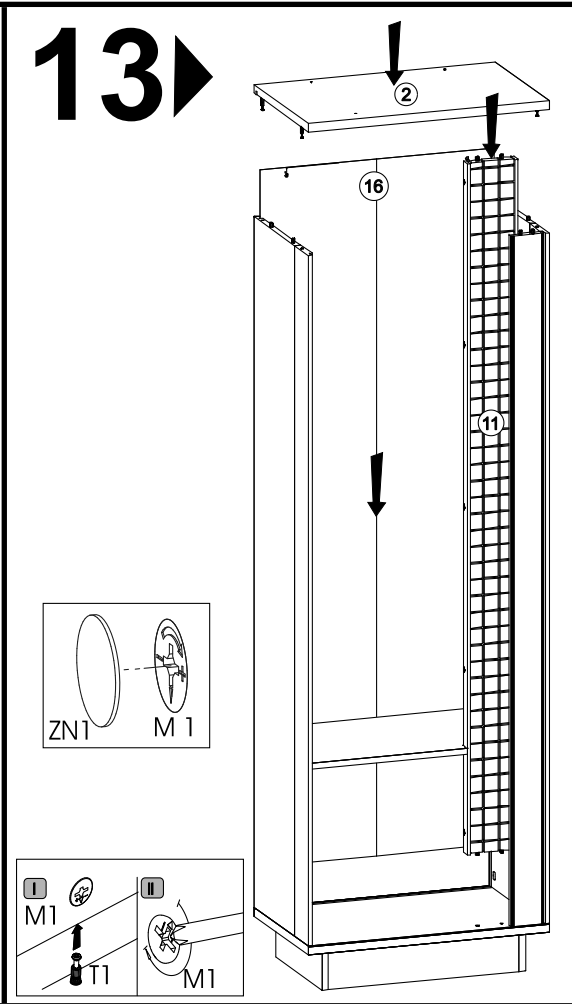
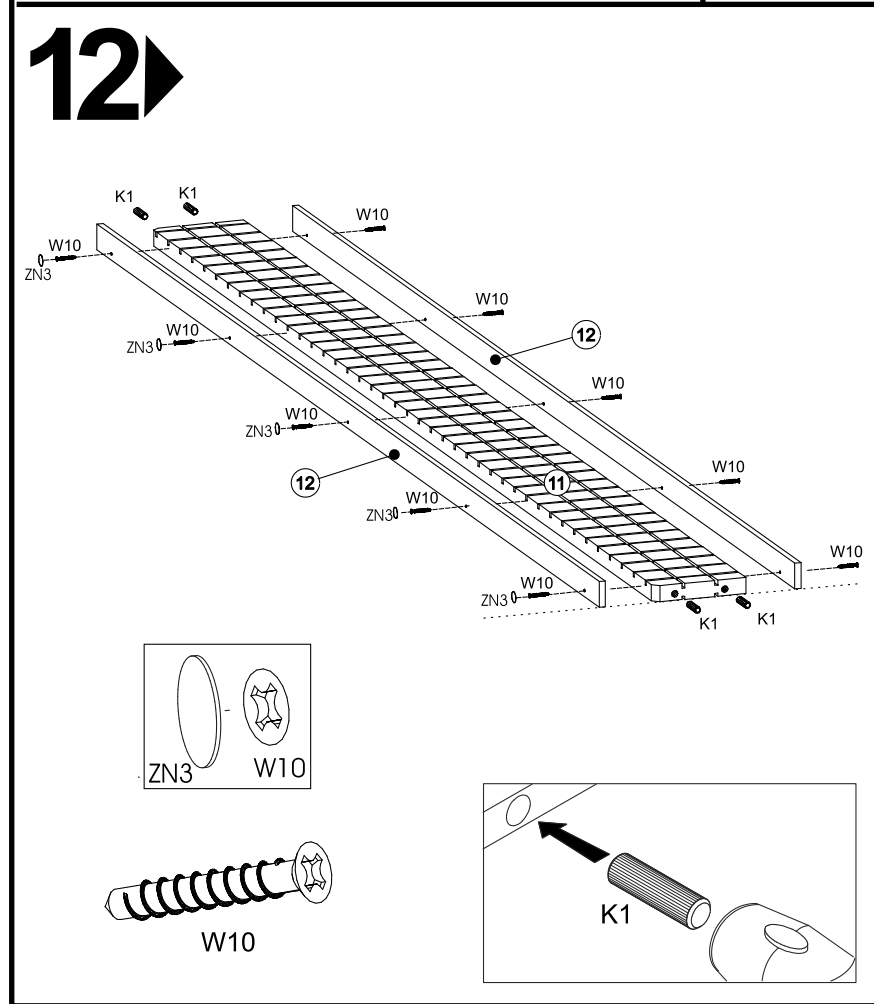
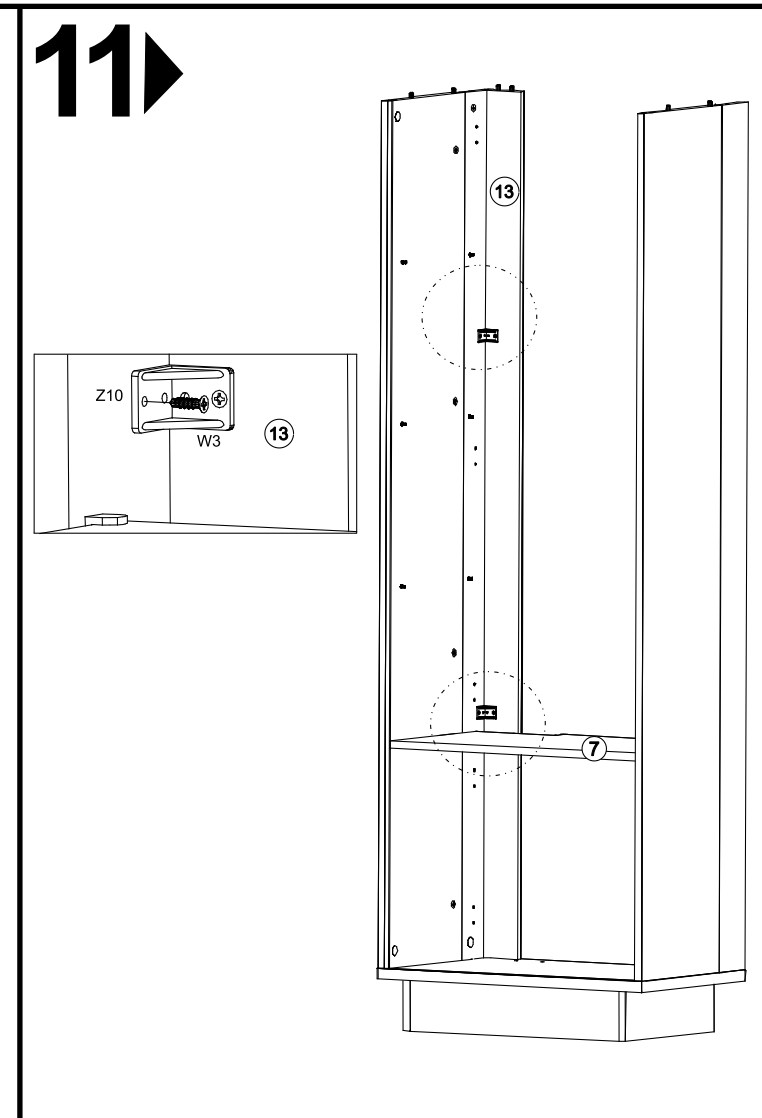
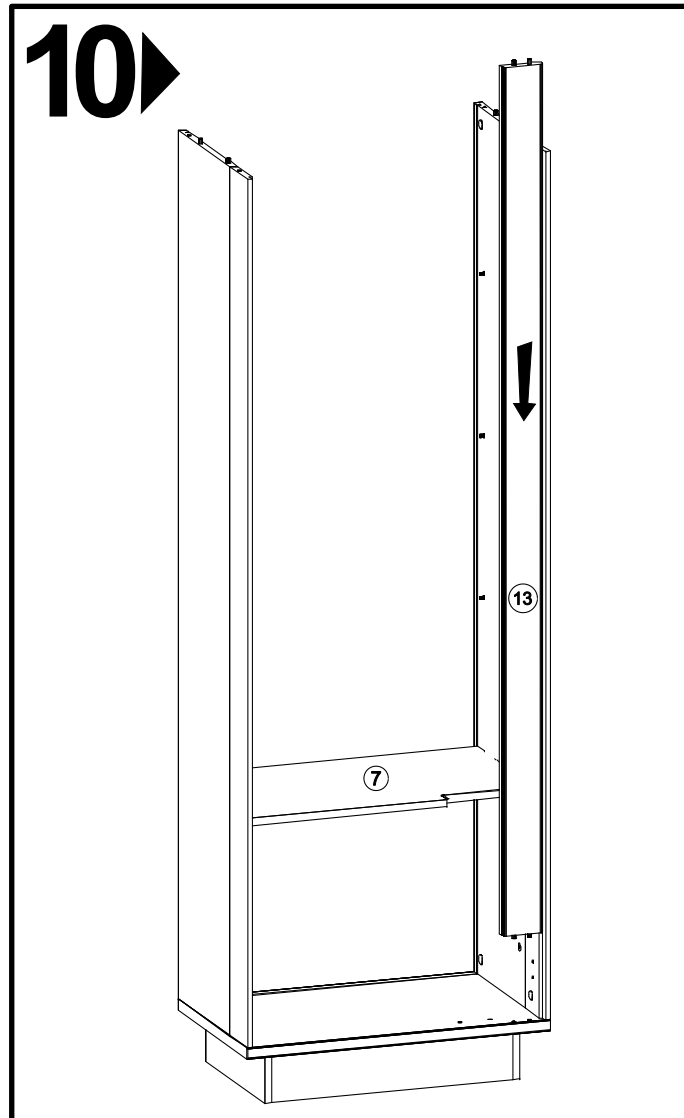
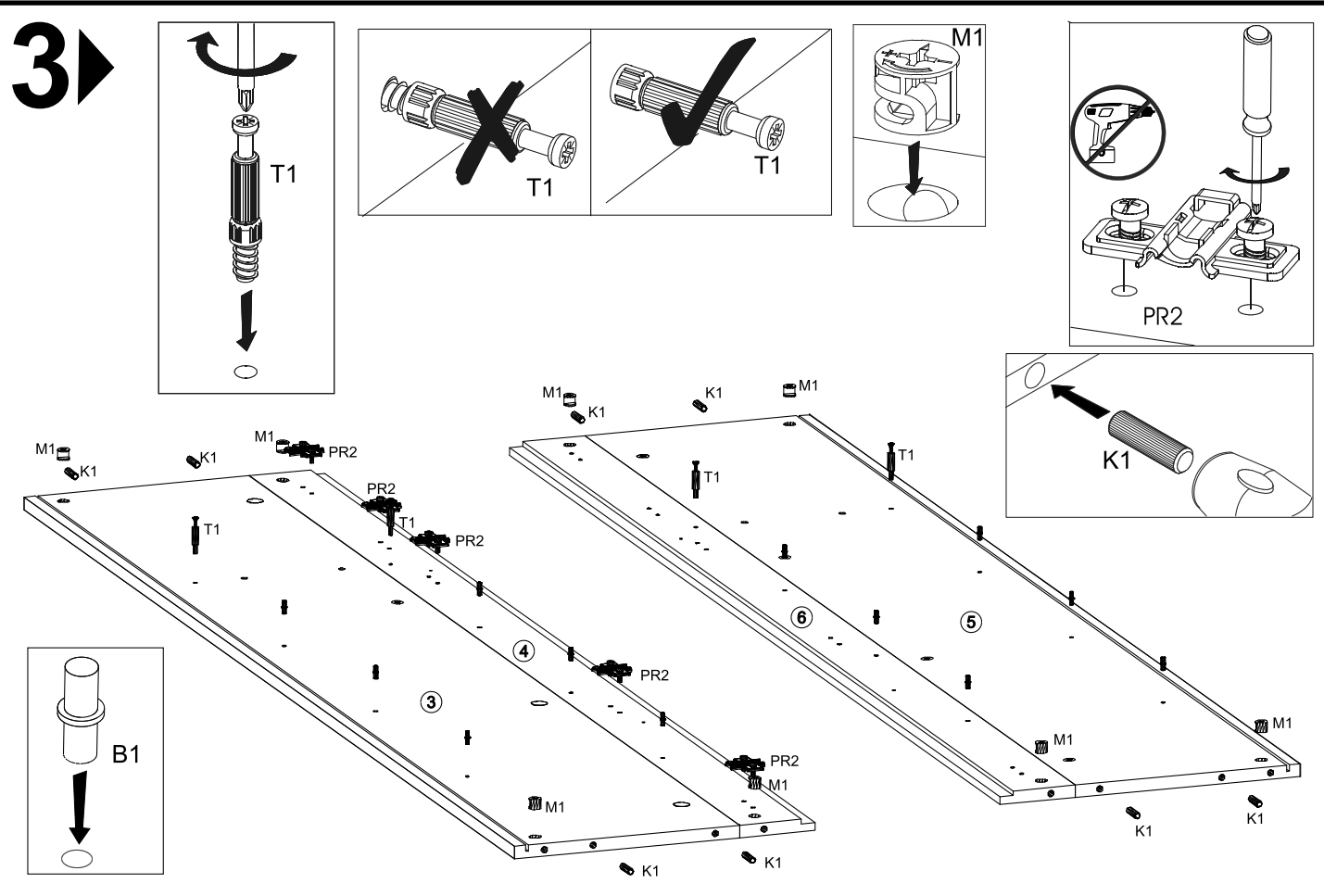
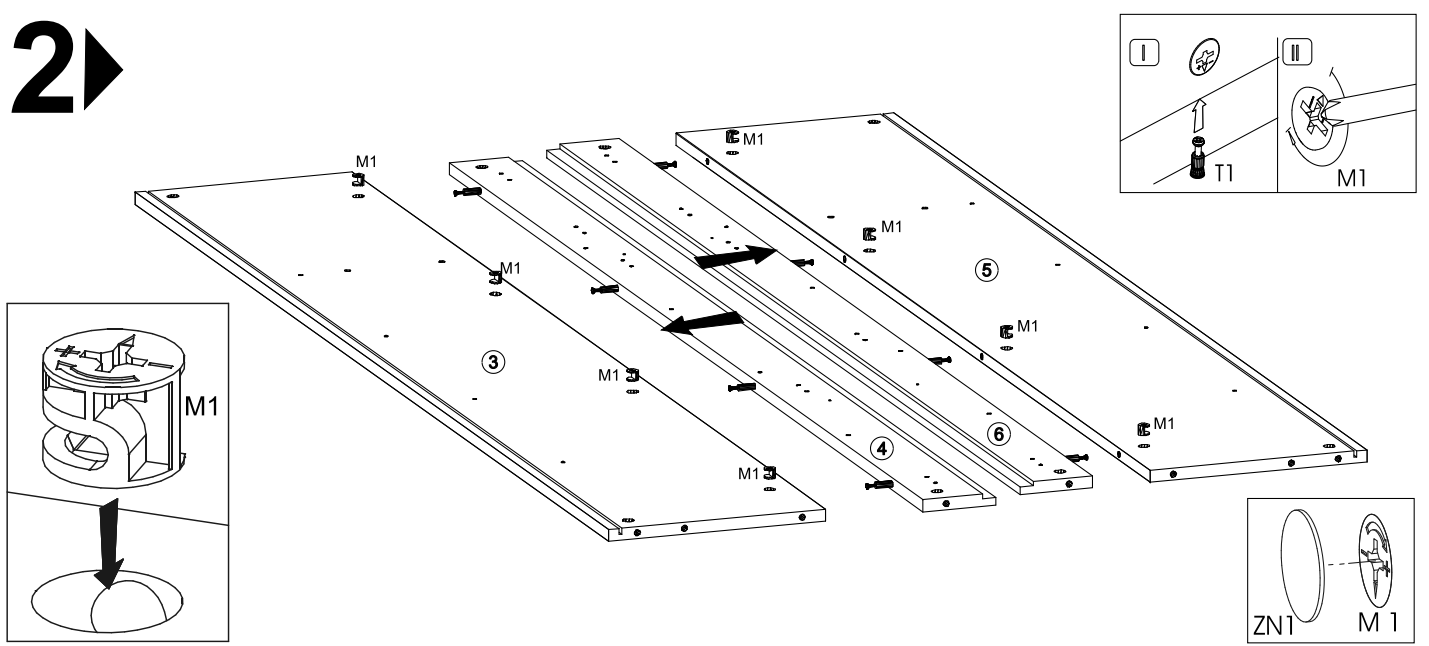
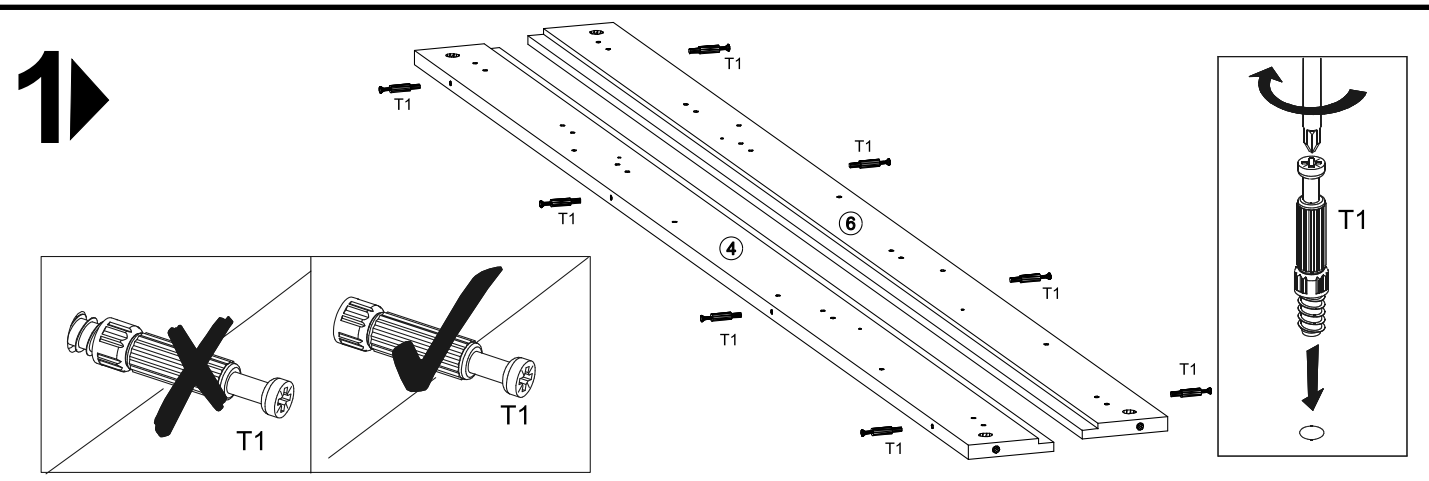

4 ▶

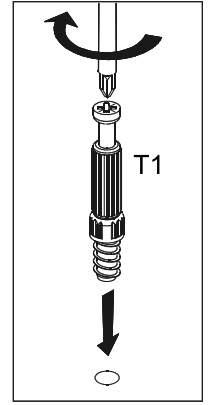
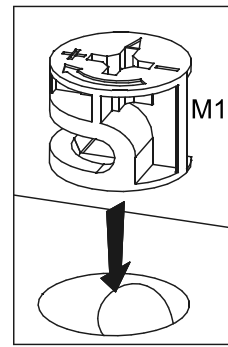
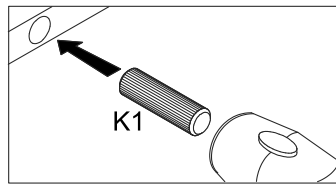
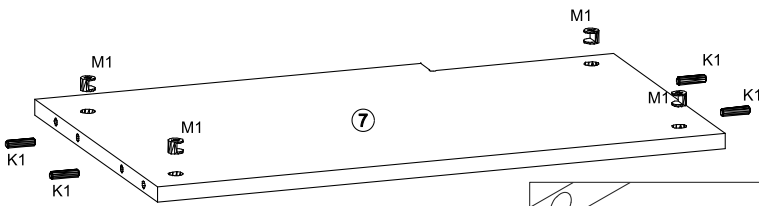
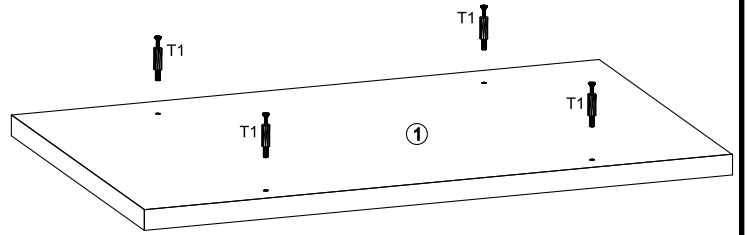
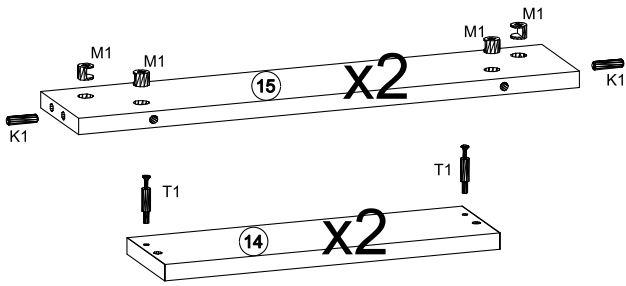
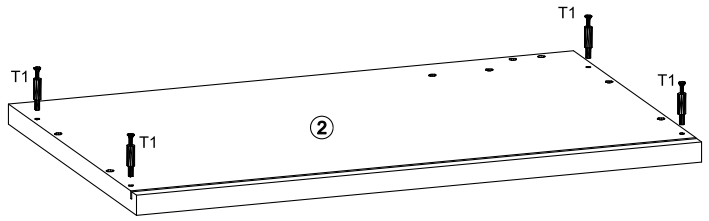
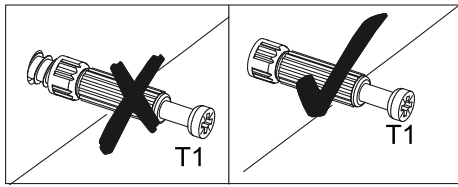

5 ▶

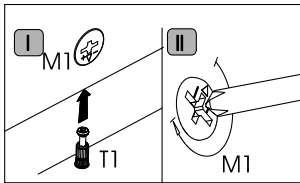
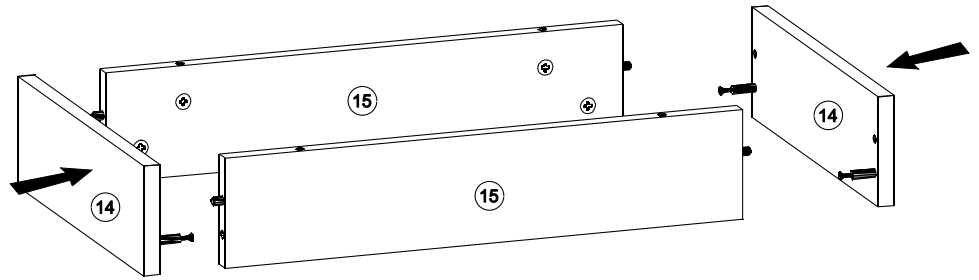

6 ▶

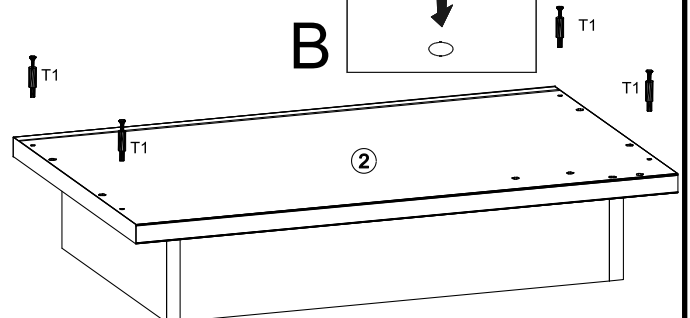
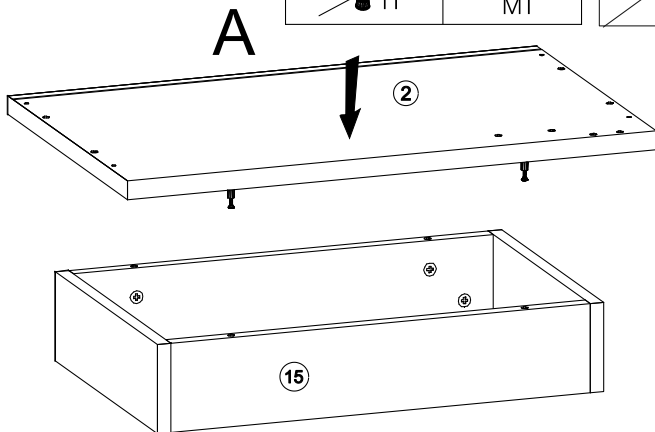
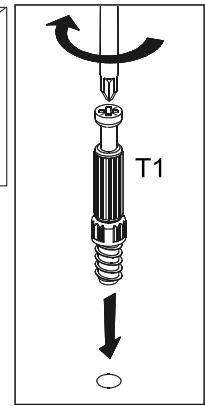
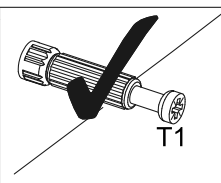
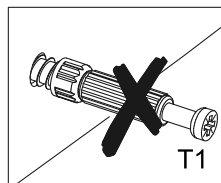
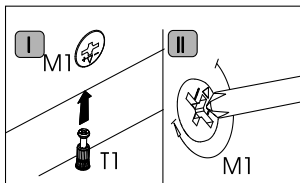

7 ▶

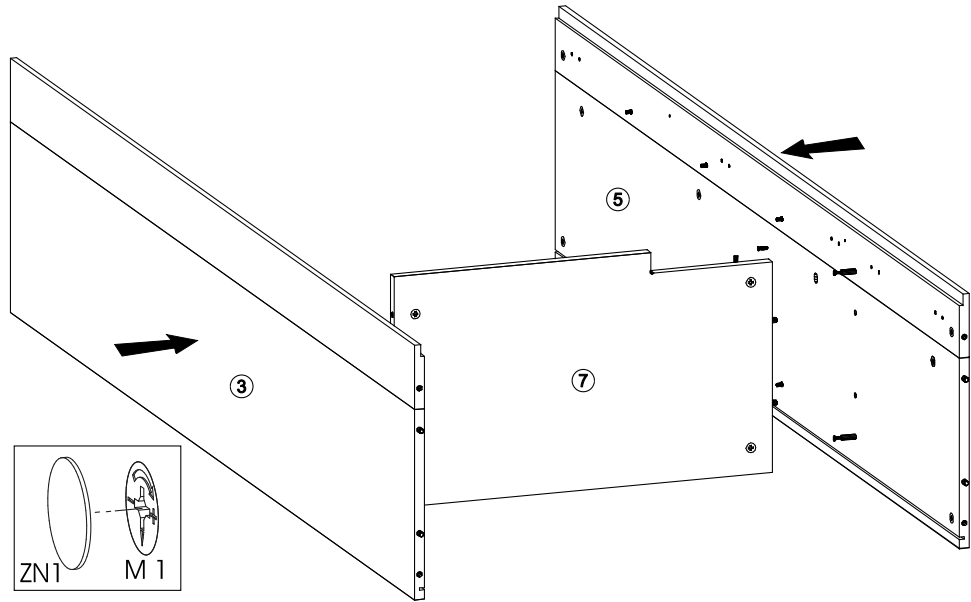
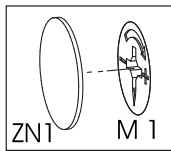
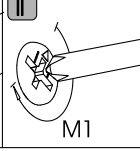
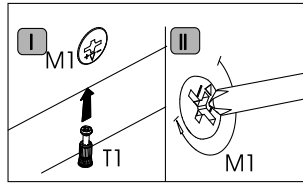

8 ▶

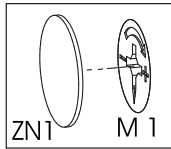
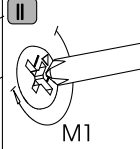
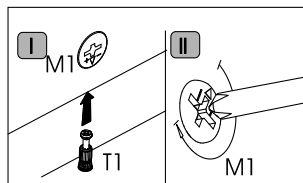
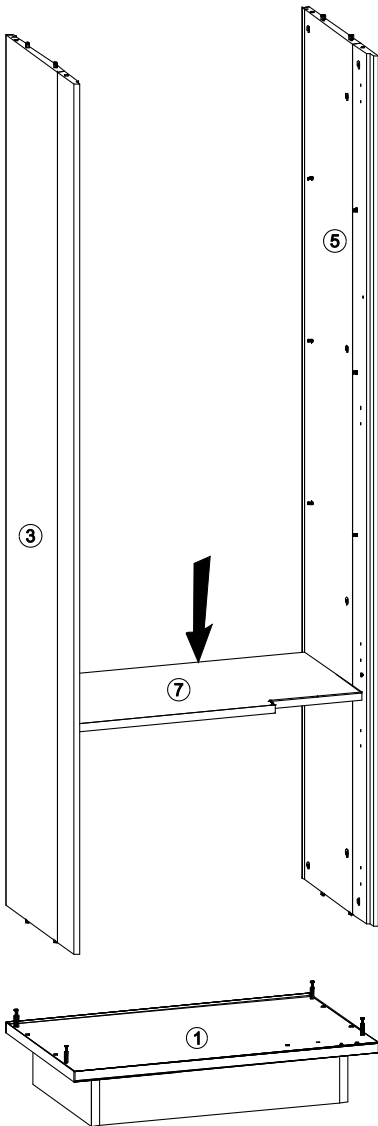

9 ▶

